

Post-installed rebar connections

Basics, design and installation

Injection mortar systems for post-installed rebars

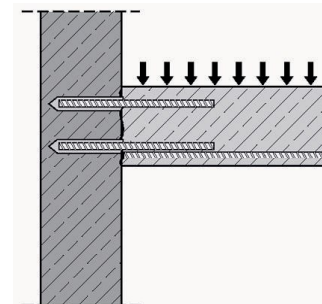

Basics, design and installation of post installed rebars

Content

| | | |
|----------|---|------------|
| 1 | Basics of post installed rebar connections | 855 |
| 1.1 | Definition of rebar..... | 855 |
| 1.2 | Advantages of post-installed rebar connections..... | 855 |
| 1.3 | Application examples..... | 856 |
| 1.4 | Anchorage and Splice..... | 858 |
| 1.5 | Bond of Cast-in Ribbed Bars..... | 859 |
| 1.6 | Specifics of Post-Installed Reinforcing Bars..... | 860 |
| 2 | Design of Post-Installed Reinforcement | 861 |
| 2.1 | Loads on Reinforcing Bars..... | 861 |
| 2.2 | Approval Based ETA/EC2 Design Method..... | 862 |
| 2.2.1 | Application Range..... | 862 |
| 2.2.2 | Design of Development and Overlap Length with Eurocode 2..... | 863 |
| 2.2.3 | Design Examples..... | 864 |
| | General information for design example..... | 866 |
| 2.3 | HIT-Rebar Design Method..... | 867 |
| 2.3.1 | Splitting Design..... | 868 |
| 2.3.2 | Strut and Tie Model for Frame Nodes..... | 870 |
| 2.3.3 | Design Examples..... | 873 |
| 2.4 | Load Case Fire..... | 878 |
| 2.5 | Fatigue of bonded-in reinforcement for joints..... | 879 |
| 2.6 | Seismic design of structural post-installed rebar..... | 881 |
| 2.7 | Corrosion behaviour..... | 882 |
| 3 | Design Programme PROFIS Rebar..... | 883 |
| 4 | References | 886 |
| 5 | Installation of Post-Installed Reinforcement | 887 |
| 5.1 | Joint to be roughened..... | 887 |
| 5.2 | Drilling..... | 887 |
| 5.2.1 | Standard Drilling..... | 887 |
| 5.3 | Hole cleaning..... | 888 |
| 5.4 | Injection and bar installation..... | 888 |
| 5.5 | Installation instruction..... | 889 |
| 5.6 | Mortar consumption estimation for post-installed rebars..... | 889 |

1 Basics of post installed rebar connections

1.1 Definition of rebar

Reinforcement anchorages or splices that are fixed into already cured concrete by Hilti HIT injection adhesives in drilled holes are called “Post-installed rebar connections” as opposed to normal, so called “cast-in” reinforcement. Many connections of rebars installed for good detailing practice will not require specific design considerations. But post-installed rebars which become part of the structural system have to be designed as carefully as the entire structure. While European Technical Approvals prove that in basic load situations, post-installed rebars behave like cast-in bars, a number of differences needs to be considered in special design situations such as fire or load cases where hooks or bends would be required for cast-in anchorages. The following chapters are intended to give the necessary information to safely design and specify post-installed reinforcement connections.

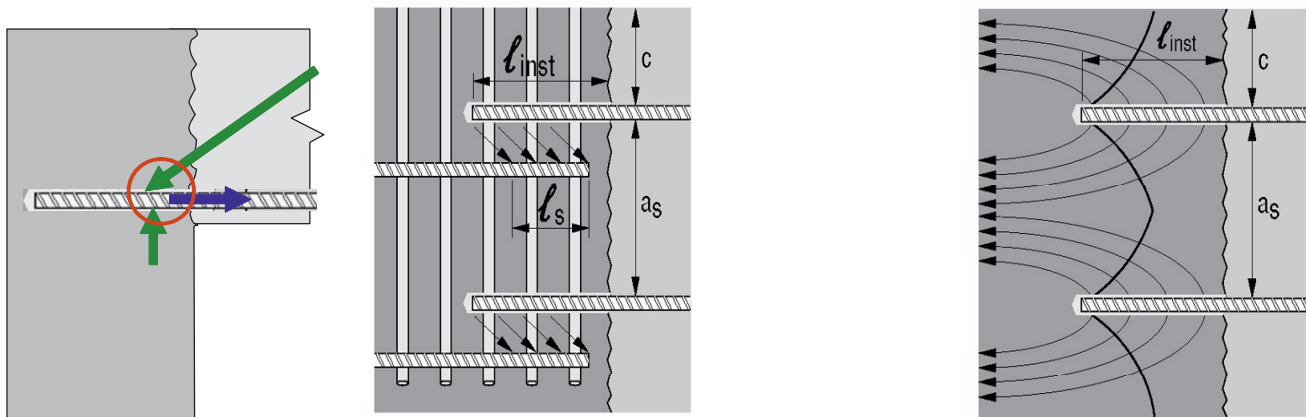

structural rebar situations: “anchorage node in equilibrium” and “splice”

anchor situation

This section of the Fastening Technology Manual deals with reinforcement connections designed according to structural reinforced concrete design principles. The task of structural rebars is to take tensile loads and since concrete failure is always brittle, reinforced concrete design assumes that concrete has no tensile strength. Therefore structural rebars can end / be anchored in only two situations:

- the bar is not needed anymore (the anchorage is a node in equilibrium without tensile stress in concrete)
- another bar takes over the tensile load (overlap splice)

Situations where the concrete needs to take up tensile load from the anchorage or where rebars are designed to carry shear loads should be considered as “rebar used as anchors” and designed according to anchor design principles as given e.g. in the guidelines of EOTA [3]

Unlike in anchor applications, reinforcement design is normally done for yielding of the steel in order to obtain ductile behaviour of the structure with a good serviceability. The deformations are rather small in correlation to the loads and the crack width limitation is around $w_k \sim 0.3\text{mm}$. This is an important factor when considering resistance to the environment, mainly corrosion of the reinforcement.

In case of correct design and installation the structure can be assumed as monolithic which allows us to look at the situation as if the concrete was poured in one. Due to the allowed high loads the required embedment depth can be up to $80d$ (diameter of rebar).

1.2 Advantages of post-installed rebar connections

With the use of the Hilti HIT injection systems it is possible to connect new reinforcement to existing structures with maximum confidence and flexibility.

- design flexibility
- reliable like cast in
- horizontal, vertical and overhead
- form work simplification
- defined load characteristics
- simple, high confidence application

1.3 Application examples

Post installed rebar connections are used in a wide range of applications, which vary from new construction projects, to structure upgrades and infrastructure requalifications.

Post-installed rebar connections in new construction projects

Diaphragm walls



Slab connections

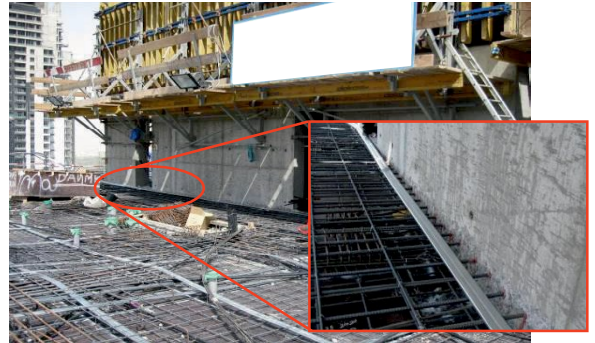

Misplaced bars



Vertical/horizontal connections



Post-installed rebar connections in structure upgrades

Wall strengthening



New slab constructions



Joint strengthening



Cantilevers/balconies



Post-installed rebar connections in infrastructure requalifications
Slab widening



Structural upgrade



Slab strengthening



Sidewalk upgrade



1.4 Anchorage and Splice

Development Length

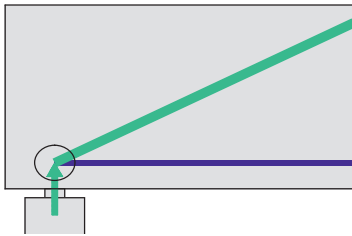

simple support

Reinforced concrete is often designed using strut and tie models. The forces are represented by trusses and the nodes of these trusses have to be in equilibrium like in the figure to the left: the concrete compression force (green line), the support force (green arrow) and the steel tensile force (blue). The model assumes that the reinforcing bar can provide its tensile force on the right side of the node while there is no steel stress at all on the left side, i.e. the bar is not needed any more on the left side of the node. Physically this is not possible, the strut and tie model is an idealization. The steel stress has to be developed on the left side of the node. This is operated by bond between steel and concrete. For the bar to be able to develop stress it needs to be extended on the left side of the node. This extension is called “development length” or “anchorage length”. The space on the

left side of the node shown in the figure above is not enough to allow a sufficient development of steel stress by bond. Possible approaches to solve this problem are shown in the figure below: either an extension of the concrete section over the support or a reduction of the development length with appropriate methods. Typical solutions are hooks, heads, welded transverse reinforcement or external anchorage.

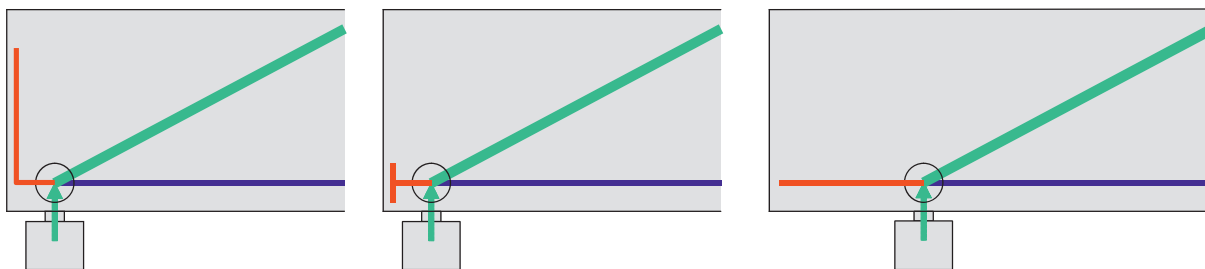

Typical solutions for anchoring of the reinforcement

Overlap Splices



Overlap splices

In case that the equilibrium of a node cannot be established without using the tensile capacity of the concrete, the tensile force of a (ending) bar must be transmitted to other reinforcement bars. A common example is starter bars for columns or walls. Due to practical reasons foundations are often built with rebars much shorter than the final column height, sticking out of the concrete. The column reinforcement will later be spliced with these. The resulting tension load in the column reinforcement due to bending on the column will be transferred into the starter bars through an overlap splice.

Forces are transmitted from one bar to another by lapping the bars. The detailing of laps between bars shall be such that:

- the transmission of the forces from one bar to the next is assured
- spalling of the concrete in the neighbourhood of the joints does not occur
- large cracks which affect the performance of the structure do not develop

1.5 Bond of Cast-in Ribbed Bars

General Behaviour

For ribbed bars, the load transfer in concrete is governed by the bearing of the ribs against the concrete. The reacting force within the concrete is assumed to be a compressive strut with an angle of 45° .

For higher bond stress values, the concentrated bearing forces in front of the ribs cause the formation of cone-shaped cracks starting at the crest of the ribs. The resulting concrete keys between the ribs transfer the bearing forces into the surrounding concrete, but the wedging action of the ribs remains limited. In this stage the displacement of the bar with respect to the concrete (slip) consists of bending of the keys and crushing of the concrete in front of the ribs.

The bearing forces, which are inclined with respect to the bar axis, can be decomposed into directions parallel and perpendicular to the bar axis. The sum of the parallel components equals the bond force, whereas the radial components induce circumferential tensile stresses in the surrounding concrete, which may result in longitudinal radial (splitting / spalling) cracks. Two failure modes can be considered:

Bond Failure

Bond failure is caused by pull-out of the bar if the confinement (concrete cover, transverse reinforcement) is sufficient to prevent splitting of the concrete cover. In that case the concrete keys are sheared off and a sliding plane around the bar is created. Thus, the force transfer mechanism changes from rib bearing to friction. The shear resistance of the keys can be considered as a criterion for this transition. It is attended by a considerable reduction of the bond stress. Under continued loading, the sliding surface is smoothed due to wear and compaction, which will result in a further decrease of the bond stress, similar to the case of plain bars.

Splitting failure:

Bond splitting failure is decisive if the radial cracks propagate through the entire cover. In that case the maximum bond stress follows from the maximum concrete confinement, which is reached when the radial cracks have penetrated the cover for about 70%. Further crack propagation results in a decrease of the confining stresses. At reaching the outer surface these stresses are strongly reduced, which results in a sudden drop of the bond stress.

Influence of spacing and cover on splitting and spalling of concrete

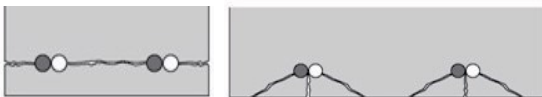

In most cases the reinforcement bars are placed close to the surface of the concrete member to achieve good crack distribution and economical bending capacity. For splices at wide spacing (normally in slabs, left part of figure left), the bearing capacity of the concrete depends only on the thickness of the concrete cover. At narrow spacing (normally in beams, right part of figure above) the bearing capacity depends on the spacing and on the thickness of the cover. In the design codes the reduction of bearing capacity of the cover is taken into account by means of multiplying factors for the splice length.

Load Transfer in Overlap Splices

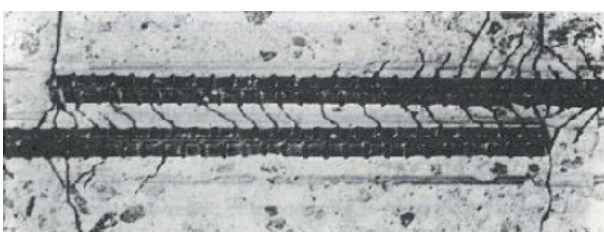

Load transfer at lap splices

The load transfer between bars is performed by means of compressive struts in the concrete, see figure left. A 45° truss model is assumed. The resulting perpendicular forces act as splitting forces. The splitting forces are normally taken up by the transverse reinforcement. Small splitting forces are attributed to the tensile capacity of the concrete. The amount of the transverse or tie reinforcement necessary is specified in the design codes.

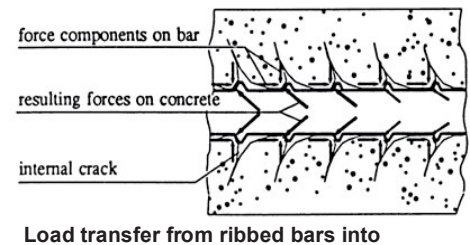

Load transfer from ribbed bars into

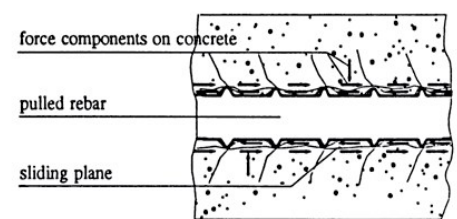

Bond failure of ribbed bars

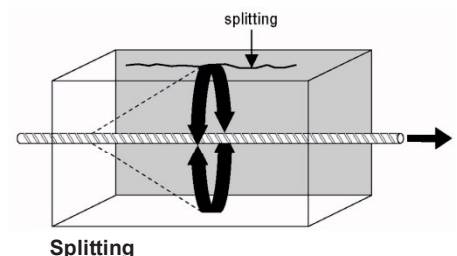

Splitting

1.6 Specifics of Post-Installed Reinforcing Bars

General Behaviour

The load transfer for post-installed bars is similar to cast in bars if the stiffness of the overall load transfer mechanism is similar to the cast-in system. The efficiency depends on the strength of the adhesive mortar against the concentrated load near the ribs and on the capacity of load transfer at the interface of the drilled hole.

In many cases the bond values of post-installed bars are higher compared to cast in bars due to better performance of the adhesive mortar. But for small edge distance and/or narrow spacing, splitting or spalling forces become decisive due to the low tensile capacity of the concrete.

Post-Installed Reinforcement Approvals

There are European Technical Approvals for post-installed rebar connections. Systems getting such approvals have to be assessed according to the EOTA technical guideline TR023 [2] (available in the EOTA website). Requirements for a positive assessment are an installation system providing high installation quality for deep holes and an adhesive fulfilling the test requirements of the guideline TR023. Obtaining the approval is basically the proof that the post-installed rebars work at least as well as cast-in rebars (with respect to bond strength and displacement); consequently, the design of the rebar anchorage is performed according to structural concrete design codes, in the case of Europe this is Eurocode 2 [1].

High Quality Adhesives Required

Assessment criteria

EOTA TR023 [2] specifies a number of tests in order to qualify products for post-installed rebar applications. These are the performance areas checked by the tests:

1. bond strength in different strengths of concrete
2. substandard hole cleaning
3. Wet concrete
4. Sustained load and temperature influence
5. Freeze-thaw conditions
6. Installation directions
7. Maximum embedment depth
8. Avoidance of air bubbles during injection
9. Durability (corrosion, chemical attack)

Approvals with or without exceptions

If an adhesive fulfills all assessment criteria of EOTA TR023, rebar connections carried out with this adhesive can be designed with the bond strength and minimum anchorage length according to Eurocode 2 [1] as outlined in section 2.2 of this document.

Adhesives which do not fully comply with all assessment criteria can still obtain an “approval with exceptions”.

- If the bond strength obtained in tests does not fulfil the specified requirements, then bond strengths lower than those given by Eurocode 2 shall be applied. These values are given in the respective ETA.
- If it cannot be shown that the bond strength of rebars post-installed with a selected product and cast-in rebars in cracked concrete ($w=0.3\text{mm}$) is similar, then the minimum anchorage length $\ell_{b,min}$ and the minimum overlap length $\ell_{o,min}$ shall be increased by a factor 1.5.

2 Design of Post-Installed Reinforcement

There are two design methods which are supported by Hilti:

1. Based on the approval (ETA) for the mortar system qualified according to EOTA TR023 [2] which allows to use the accepted structural code Eurocode 2 EN 1992-1-1:2011 [1], chapters 8.4: "anchorage of longitudinal reinforcement" and 8.7 "Laps and mechanical couplers" taking into account some adhesive specific parameters. This method is called

"ETA/EC2 Design Method"

paragraph 2.2 gives an overview of the design approach and design examples, technical data from the rebar approvals can be found in section 6.

2. For applications which are not covered by "ETA/EC2 Design Method", the design approach of Eurocode 2 has been extended on the basis of extensive internal as well as external research [6 - 8] as well as assessments [9]. This method is called

"Hit Rebar Design Method"

which offers an extended range of applications (please see section 2.3 for an overview of the design approach as well as design examples.

2.1 Loads on Reinforcing Bars

Strut and Tie Model

Strut-and-tie models are used to calculate the load path in reinforced concrete members. Where a non-linear strain distribution exists (e.g. supports) strut-and-tie models may be used {Clause 6.5.1(1), EC2: EN 1992-1-1:2011}.

Strut-and-tie models consist of struts representing compressive stress fields, of ties representing the reinforcement and of the connecting nodes. The forces in the elements of a strut-and-tie model should be determined by maintaining the equilibrium with the applied loads in ultimate limit state. The ties of a strut-and-tie model should coincide in position and direction with the corresponding reinforcement {Clause 5.6.4, EC2: EN 1992-1-1:2011 Analysis with strut and tie models}.

In modern concrete design codes the strut angle θ can be selected within certain limits, roughly between 30° and 60° . Many modern concrete design codes show a figure similar to the following:

The equilibrium equations in horizontal direction gives the force in the reinforcement:

$$F_{sl} = \frac{M_y}{z} + \frac{N_x}{2} + \frac{V_z \cdot \cot \theta}{2}$$

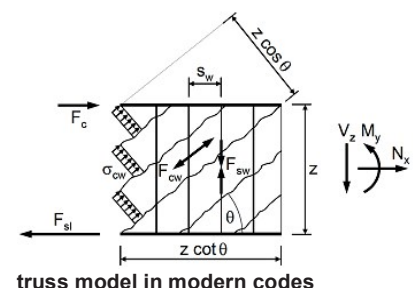
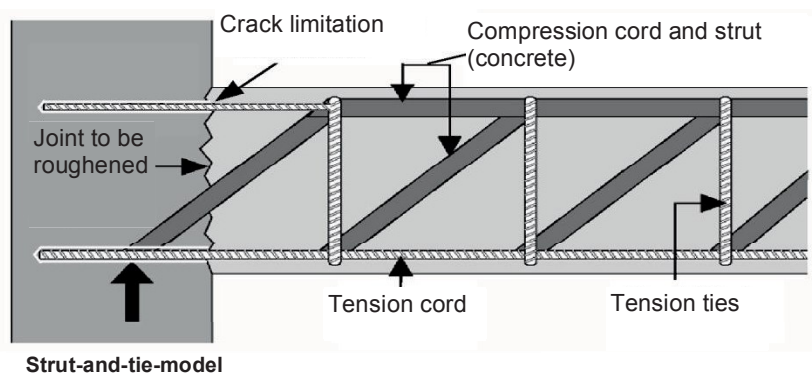

2.2 Approval Based ETA/EC2 Design Method

2.2.1 Application Range

The principle that rebars are anchored “where they are not needed any more” (anchorage) or where the force is taken over by another bar (splice) and the fact that only straight rebars can be post-installed lead to the application range shown by the figures taken from EOTA TR023 [2]:

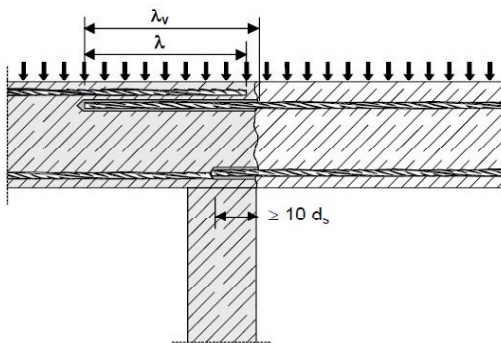

Figure 1.1: Overlap joint for rebar connections of slabs and beams

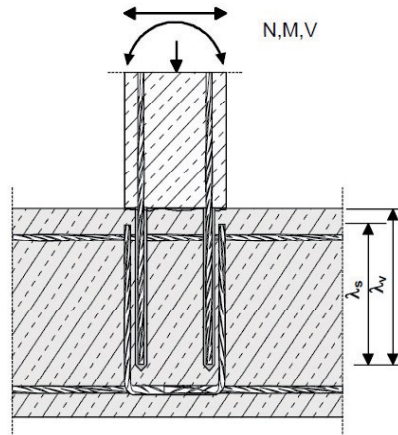

Figure 1.2: Overlap joint at a foundation of a column or wall where the rebars are stressed in tension

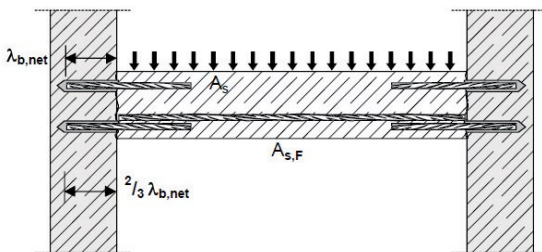

Figure 1.3: End anchoring of slabs or beams, designed as simply supported

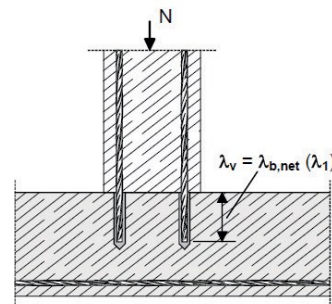

Figure 1.4: Rebar connection for components stressed primarily in compression. The rebars are stressed in compression

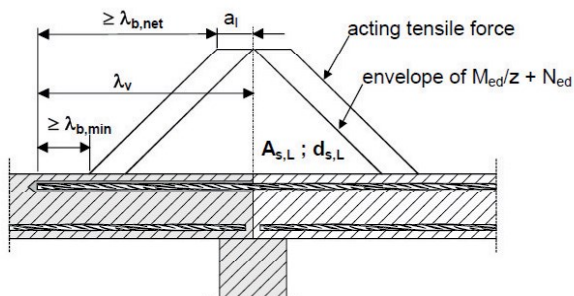

Figure 1.5: Anchoring of reinforcement to cover the line of acting tensile force

Note to Figure 1.1 to 1.5:

In the Figures no transverse reinforcement is plotted, the transverse reinforcement as required by EC 2 shall be present.

The shear transfer between old and new concrete shall be designed according to EC 2.

Application range according to EOTA TR023

All other applications lead to tensile stress in the concrete. Therefore, the principle “works like cast-in” would not be true any more. Such cases must be considered with specific models exceeding the approval based approach to post-installed rebar connections.

2.2.2 Design of Development and Overlap Length with Eurocode 2

The following reflect the design relevant sections from EOTA TR023, chapter 4 “Assumptions under which the fitness of use is to be assessed” and from the specific European Technical Approvals:

Design method for post-installed rebar connections

- The post-installed rebar connections assessed according to this Technical Report shall be designed as straight cast-in-place rebars according to EC2 using the values of the design bond resistance f_{bd} for deformed bars as given in the relevant approval.

- Overlap joint for rebars: For calculation of the effective embedment depth of overlap joints the concrete cover at end-face of the post-installed rebar c_1 shall be considered:

$$l_v \geq l_0 + c_1$$

with: l_0 = required lap length

c_1 = concrete cover at end-face of bonded-in rebar

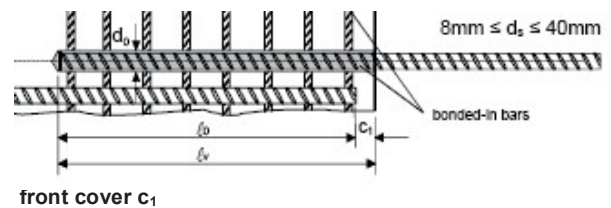

- The definition of the bond region in EC2 is valid also for post-installed rebars.

- The conditions in EC2 concerning detailing (e.g. concrete cover in respect to bond and corrosion resistance, bar spacing, transverse reinforcement) shall be complied with.

- The transfer of shear forces between new and old concrete shall be designed according to EC2 [1].

Additional provisions

- To prevent damage of the concrete during drilling the following requirements have to be met:

- Minimum concrete cover:

$$c_{min} = 30 + 0,06 l_v \geq 2d_s \text{ (mm) for hammer drilled holes}$$

$$c_{min} = 50 + 0,08 l_v \geq 2d_s \text{ (mm) for compressed air drilled holes}$$

The factors 0,06 and 0,08 should take into account the possible deviations during the drilling process. This value might be smaller if special drilling aid devices are used.

Furthermore the minimum concrete cover given in clause 4.4.1.2, EC2: EN 1992-1-1: 2004 shall be observed.

- Minimum clear spacing between two post-installed bars $a = 40 \text{ mm} \geq 4d_s$

- To account for potentially different behaviour of post-installed and cast-in-place rebars in cracked concrete,

- in general, the minimum lengths $l_{b,min}$ and $l_{o,min}$ given in the EC 2 for anchorages and overlap splices shall be increased by a factor of 1.5. This increase may be neglected under certain conditions. The relevant approval states under which conditions the factor can be neglected for a specific adhesive.

Preparation of the joints

- The surface of the joint between new and existing concrete should be prepared (roughing, keying) according to the envisaged intended use according to EC2.

- In case of a connection being made between new and existing concrete where the surface layer of the existing concrete is carbonated, the layer should be removed in the area of the new reinforcing bar (with a diameter $d_s+60\text{mm}$) prior to the installation of the new bar.

Transverse reinforcement

The requirements of transverse reinforcement in the area of the post-installed rebar connection shall comply with clause 8.7.4, EC2: EN 1992-1-1:2011.

2.2.3 Design Examples

a) End support of slab, simply supported

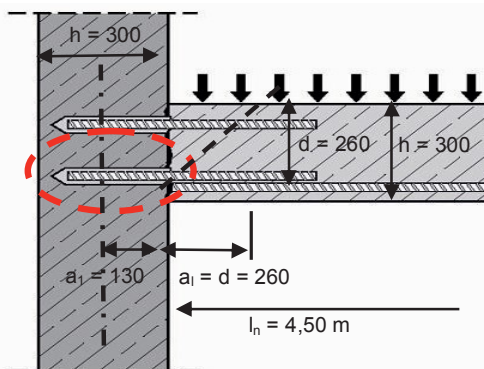

slab: $l_n = 4,50\text{m}$, $Q_k = 20\text{ kN/m}^2$, $h = 300\text{ mm}$, $d = 260\text{ mm}$

wall: $h = 300\text{ mm}$

Concrete strength class: C20/25, dry concrete

Reinforcement: $f_{yk} = 500\text{ N/mm}^2$, $\gamma_s = 1.15$

Loads: $G_k = 25\text{ kN/m}^3 \cdot h = 7.5\text{ kN/m}^2$;
 $S_d = (1.50 \cdot Q_d + 1.35 \cdot G_k) = 40.1\text{ kN/m}^2$

Structural analysis (design forces):

$$M_{Ed} = S_d \cdot l_n^2 / 8 = 102\text{ kNm/m}$$

$$V_{Ed} = S_d \cdot l_n / 2 = 90.3\text{ kN/m}$$

Bottom reinforcement required at mid span:

$$A_{s,rqd,m} = (M_{sd} \cdot \gamma_s) / (0.9 \cdot d \cdot f_{yk}) = 998\text{ mm}^2/\text{m}$$

reinforcement provided at mid span: $\varnothing 16$, $s = 200\text{ mm}$

$$A_{s,prov,m} = 1005\text{ mm}^2/\text{m}$$

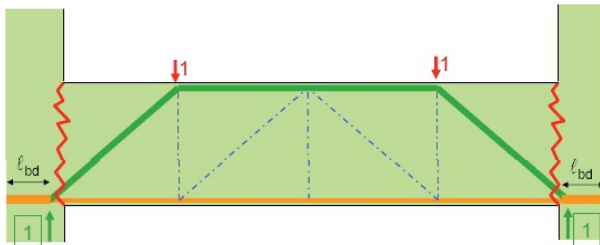

Bottom reinforcement at support:

Tension force to be anchored: $F_E = |V_{Ed}| \cdot a_l / (0.9d) = 100\text{ kN/m}$ {Clause 9.2.1.4(2), EC2: EN 1992-1-1:2004}

Steel area required: $A_{s,rqd} = F_E \cdot \gamma_s / f_{yk} = 231\text{ mm}^2/\text{m}$

Minimum reinforcement to be anchored at support:

$A_{s,min} = k_c \cdot k \cdot f_{ct,eff} \cdot A_s / \sigma_s = 0,4 \cdot 1 \cdot 2,2 \cdot 150 \cdot 1000 / 500 = 264\text{ mm}^2/\text{m}$ {Clause 7.3.2(2), EC2: EN 1992-1-1:2011}

$A_{s,min} = 0,50 \cdot 988 = 499\text{ mm}^2/\text{m}$ {Clause 9.3.1.2(1), EC2: EN 1992-1-1:2011}

$A_{s,min} = 0,25 \cdot 1010 = 251\text{ mm}^2/\text{m}$ {Clause 9.2.1.4(1), EC2: EN 1992-1-1:2011}

Decisive is $499\text{ mm}^2/\text{m} \Rightarrow$ reinforcement provided: $\varnothing 12$, $s = 200\text{ mm} \Rightarrow A_{s,prov} = 565\text{ mm}^2/\text{m}$;

Installation by wet diamond core drilling: Hilti HIT-RE 500 is suitable adhesive (see Tech data, sect. 2.2.3)

Basic anchorage length {EC2: EN 1992-1-1:2004, section 8.4.3}:

$$l_{b,rqd} = (d_s / 4) \times (\sigma_{sd} / f_{bd})$$

with: $d_s =$ diameter of the rebar = 12 mm

$\sigma_{sd} =$ calculated design stress of the rebar = $(A_{s,rqd} / A_{s,prov}) \cdot (f_{yk} / \gamma_s) = (231 / 565) \cdot (500 / 1,15) = 177\text{ N/mm}^2$

$f_{bd} =$ design value of bond strength according to corresponding ETA (= 2,3 N/mm²)

$$l_{b,rqd} = (12 / 4) \times (177 / 2.3) = 231\text{ mm}$$

Design anchorage length {EC2: EN 1992-1-1:2011, section 8.4.4}:

$$l_{bd} = \alpha_1 \alpha_2 \alpha_3 \alpha_4 \alpha_5 l_{b,rqd} \geq l_{b,min}$$

with: $l_{b,rqd}$ as above

$\alpha_1 = 1,0$ for straight bars

$\alpha_2 = 1 - 0,15(c_d - \varnothing) / \varnothing$ ($0,7 \leq \alpha_2 \leq 1,0$)

α_2 is for the effect of concrete cover, in this case half the clear spacing: $c_d = (200 - 12) / 2 = 94\text{ mm}$

$\alpha_2 = 0,7$

Straight bars, $c_d = \min(a/2, c_1, c)$

$\alpha_3 = 1,0$ because of no transverse reinforcement

$\alpha_4 = 1,0$ because of no welded transverse reinforcement

$\alpha_5 = 1,0$ influence of transverse pressure is neglected in this example

$$\ell_{bd} = 0,7 \cdot 231 = 162 \text{ mm}$$

minimum anchorage length {Clause 8.4.4(1), EC2: EN 1992-1-1:2011}:

$$\ell_{b,min} = \max \{0,3\ell_{b,rqd}; 10\phi; 100\text{mm}\} = 120 \text{ mm}$$

ℓ_{bd} controls \rightarrow drill hole length $l_{ef} = 162 \text{ mm}$

Top reinforcement at support:

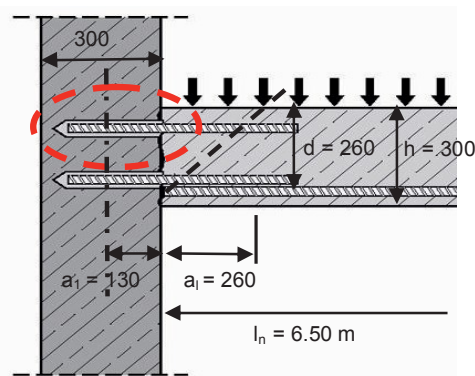

Minimum reinforcement:

- 25% of bottom steel required at mid-span
{Clause 9.3.1.2(2), EC2: EN 1992-1-1:2004}
 $A_{s,req} = 0,25 \cdot 988 = 247 \text{ mm}^2/\text{m}$
- requirement for crack limitation :
{Clause 7.3.2(2), EC2: EN 1992-1-1:2004}
 $A_{s,min} = 0,4 \cdot 1 \cdot 2,2 \cdot 150 \cdot 1000 / 435 = 303 \text{ mm}^2/\text{m}$

Decisive is $303 \text{ mm}^2/\text{m}$

\Rightarrow reinforcement provided: $\varnothing 10$, $s = 200 \text{ mm}$; $A_{s,prov} = 393 \text{ mm}^2/\text{m}$

Design stress in bar: $\sigma_{sd} = f_{yd} \cdot A_{s,min} / A_{s,prov} = 335 \text{ N/mm}^2$

$$\ell_{b,rqd} = (d_s / 4) \times (\sigma_{sd} / f_{bd}) = (10 / 4) \times (335 / 2.3) = 364 \text{ mm}$$

$$\ell_{bd} = \alpha_1 \alpha_2 \alpha_3 \alpha_4 \alpha_5 \ell_{b,rqd} = 0,7 \cdot 364 = 255 \text{ mm}$$

$$\ell_{b,min} = \max \{0,3\ell_{b,rqd}; 10\phi; 100\text{mm}\} = 120 \text{ mm}$$

Therefore, drill hole length $l_{ef} = 255 \text{ mm}$

If wet diamond core drilling is used {Clause 8.4.4(1), EC2: EN 1992-1-1:2011}:

$$\ell_{b,min} = \max \{0,3\ell_{b,rqd}; 10\phi; 100\text{mm}\} \cdot 1.5 = 180 \text{ mm} \quad (\text{as wet diamond core drilling is used, the minimum values according do EC2 have to be multiplied by 1.5, see tech data})$$

\rightarrow in this case the minimum length will control, drill hole length for the lower layer will be $l_{ef,diamond,lower} = 180 \text{ mm}$ and will remain for the upper layer $l_{ef,diamond,upper} = 255 \text{ mm}$.

b) splice on support

General information for design example

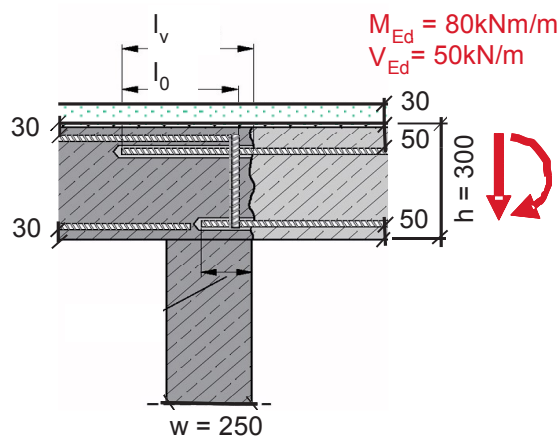

$M_{Ed} = 80 \text{ kNm/m}$
 $V_{Ed} = 50 \text{ kN/m}$

- Bending moment: $M_{Ed} = 80 \text{ kNm/m}$; shear: $V_{Ed} = 50 \text{ kN/m}$
- slab: cover cast-in bars $c_c = 30 \text{ mm}$ (top, bottom); cover new bars: $c_n = 50 \text{ mm}$ $h = 300 \text{ mm}$;
- top reinforcement (new and existing): $\phi 16$, $s = 200 \text{ mm}$; $A_{s,prov} = 1005 \text{ mm}^2/\text{m}$; cover to face $c_1 = 30 \text{ mm}$
- bottom reinforcement: $\phi 10$, $s = 200 \text{ mm}$; $A_{s,prov} = 393 \text{ mm}^2/\text{m}$
- Concrete strength class: C25/30
- Properties of reinforcement: $f_{yk} = 500 \text{ N/mm}^2$
- Fire resistance: R60 (1 hour),
Light weight plaster for fire protection: $t_p = 30 \text{ mm}$;
maximum steel stress in fire $\sigma_{Rd,fi} = 322 \text{ N/mm}^2$
- Hilti HIT-RE 500

Cast-in reinforcement top

$$l_{0,ci} = \alpha_1 \alpha_2 \alpha_3 \alpha_5 \alpha_6 l_{b,rqd,ci} \geq l_{0,min}$$

| | | |
|--|----------------------------|---------------------------|
| $\eta_1 = (d - \phi/2 > 250 \text{ mm})$ | 0.7 | poor bond condition |
| $Z_{ci} =$ | 239 mm | (from static calculation) |
| $A_{s,req} = (M_{Ed}/z) \cdot (\gamma_s/f_{yk}) = (80/0.239) \cdot (1.15/0.5) =$ | 770 mm^2/m | |
| $\sigma_{sd} = (A_{s,rqd} / A_{s,prov}) \cdot (f_{yk}/\gamma_s) = (770 / 1005) \cdot (500 / 1.15) =$ | 333 N/mm^2 | |
| $f_{bd} = 2.25 \cdot \eta_1 \cdot 0.7 \cdot 0.3 \cdot f_{ck}^{2/3} / \gamma_c = 2.25 \cdot 0.7 \cdot 0.7 \cdot 0.3 \cdot 25^{2/3} / 1.5 =$ | 1.89 N/mm^2 | (ETA 08/0105) |

$$l_{b,rqd,pi} = (\phi / 4) \cdot (\sigma_{sd} / f_{bd}) = (16 / 4) \cdot (333 / 1.89) = 705 \text{ mm}$$

| | | |
|--|------|-----------------------------|
| $\alpha_1 =$ | 0.7 | hooked end of cast-in bars |
| $\alpha_2 = (1 - 0.15(c_d - \phi) / \phi \geq 0.7) = 1 - 0.15(30 - 16) / 16 =$ | 0.87 | |
| $\alpha_3 =$ | 1.0 | no transverse reinforcement |
| $\alpha_5 =$ | 1.0 | no transverse pressure |
| $\alpha_6 =$ | 1.5 | splice factor |

$$l_{0,min} = \max\{0.3 \cdot 1.5 \cdot 705; 15 \cdot 16; 200\} = 317 \text{ mm}$$

$$l_{0,ci} = 0.70 \cdot 0.87 \cdot 1.5 \cdot 705 = 643 \text{ mm}$$

Post-installed reinforcement top

The required design lap length l_0 shall be determined in accordance with EC2: EN 1992-1-1:2004, section 8.7.3:

$$l_{0,pi} = \alpha_1 \alpha_2 \alpha_3 \alpha_5 \alpha_6 l_{b,rqd,pi} \geq l_{0,min}$$

| | | |
|--|----------------------------|---------------------------|
| $d = h - c_n - \phi/2 = 300 - 50 - 16/2 =$ | 242 mm | |
| $\eta_1 = (d - \phi/2 < 250 \text{ mm})$ | 1.0 | good bond condition |
| $Z =$ | 228 mm | (from static calculation) |
| $A_{s,req} = (M_{Ed}/z) \cdot (\gamma_s/f_{yk}) = (80/0.228) \cdot (1.15/0.5) =$ | 807 mm^2/m | |
| $\sigma_{sd} = (A_{s,rqd} / A_{s,prov}) \cdot (f_{yk}/\gamma_s) = (807 / 1005) \cdot (500 / 1.15) =$ | 349 N/mm^2 | |
| $f_{bd} = \text{design value of bond strength according to 2.2.3} =$ | 2.7 N/mm^2 | (ETA 08/0105) |

$$l_{b,rqd,pi} = (\phi / 4) \cdot (\sigma_{sd} / f_{bd}) = (16 / 4) \cdot (349 / 2.7) = 516 \text{ mm}$$

| | | |
|--------------|-----|-------------------|
| $\alpha_1 =$ | 1.0 | for straight bars |
|--------------|-----|-------------------|

| | | |
|--|--------|-----------------------------|
| $\alpha_2 = (1 - 0.15(c_d - \phi)/\phi \geq 0.7) = 1 - 0.15(50 - 16)/16 =$ | 0.7 | |
| $\alpha_3 =$ | 1.0 | no transverse reinforcement |
| $\alpha_5 =$ | 1.0 | no transverse pressure |
| $\alpha_6 =$ | 1.5 | splice factor |
| $l_{0,min} = \max\{0.3 \cdot 1.5 \cdot 515; 15 \cdot 16; 200\} =$ | 240 mm | |
| $l_{0,pi} = 0.7 \cdot 1.5 \cdot 530 =$ | 542 mm | |

Fire resistance post-installed reinforcement top:

| | | |
|--|-----------------------|-----------------------------------|
| $\gamma_L =$ | 1.4 | assumed safety factor loads |
| $\sigma_{sd,fi} = \sigma_{sd}/\gamma_L = 358/1.4 =$ | 249 N/mm ² | $< \sigma_{Rd,fi} \rightarrow ok$ |
| $c_{fi} = c_n + t_p = 30 + 50 =$ | 80 mm | cover effective against fire |
| $f_{bd,fi} = (\text{sect. 2.4.1, table fire parallel})$ | 1.4 N/mm ² | (DIBt Z-21.8-1790) |
| $l_{0,pi,fi} = (\phi/4) \cdot (\sigma_{sd,fi}/f_{bd,fi}) = (16/4) \cdot (249/1.4) =$ | 711 mm | |

Embedment depth for post-installed rebars top:

| | | |
|--|--------|------------------------------------|
| $e = [(s/2)^2 + (c_n - c_c)^2]^{0.5} - \phi = [100^2 + (50 - 30)^2]^{0.5} - 16 =$ | 86 mm | clear spacing between spliced bars |
| $\Delta l_0 = e - 4\phi = 86 - 4 \cdot 16 =$ | 22 mm | |
| $l_0 = \max(l_{0,pi}; l_{0,pi,fi}; l_{0,ci}; l_{0,min}) + \Delta l_0 = 711 + 22 =$ | 733 mm | |
| $c_f =$ | 30 mm | |
| $w/2 =$ | 125 mm | |
| $l_v = l_0 + \max(w/2; c_f) = 733 + 125 =$ | 858 mm | |

Embedment depth for post-installed rebars bottom:

Concrete in compression, no force on bars \rightarrow anchorage with minimum embedment length.

| | | |
|---|--------|---------------|
| $f_{min} =$ | 1.0 mm | (ETA 08/0105) |
| $l_{b,min} = f_{min} \cdot \max(10\phi; 100\text{mm}) = 1.0 \cdot \max(10 \cdot 10; 100) =$ | 100 mm | |
| $w/2 =$ | 125 mm | |
| $l_v = l_{b,min} + w/2 = 100 + 125 =$ | 225 mm | |

2.3 HIT-Rebar Design Method

While the EC2/ETA design method is of direct and simple use, it has two main drawbacks

- The connection of simply supported slabs to walls is only possible if the wall is thick enough to accommodate the anchorage length. As reductions of the anchorage length with hooks or welded transverse reinforcement cannot be made with post-installed reinforcement, it often occurs that the wall is too small. However, if the confinement of the concrete is large enough, it is actually possible to use the full

bond strength of the adhesive rather than the bond strength given by Eurocode 2 [1]. The so-called “splitting design” allows to design for the full strength of the adhesive [5, 9].

- According to traditional reinforced concrete principles, moment resisting frame node connections required bent connection bars. In this logic, they can therefore not be made with straight post-installed rebar connections. The frame node model is a proposed strut and tie model to design moment resisting frame node connections with straight connection bars [6, 7].

2.3.1 Splitting Design

The factor α_2 of Eurocode 2 [1] gives an explicit consideration for splitting and spalling as a function of concrete cover and bar spacing. European Technical Approvals recommend the same procedure for post-installed rebar connections:

$$l_{bd, spl} = \frac{\phi}{4} \cdot \frac{\sigma_{sd}}{f_{bd}} \cdot \alpha_2$$

f_{bd} according to technical data (ETA's for post-installed anchors)

$$\alpha_2 = 1 - 0.15 \cdot \frac{c_d - \phi}{\phi}$$

$$c_d = \min(c_x; c_y; s/2)$$
(1)

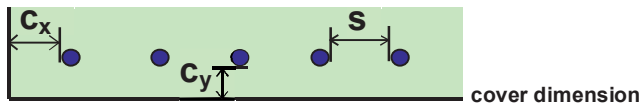

This function is adapted and extended for post-installed reinforcement for the HIT-Rebar design concept: Eurocode 2 limits the α_2 value to $\alpha_2 \geq 0.7$. This can be interpreted as follows: as long as α_2 exceeds 0.7, spalling of the concrete cover or splitting between bars will be the controlling mode of failure. If α_2 is less than 0.7, corresponding to cover dimensions of $c_d/\phi > 3$, the cover is large enough so that splitting cannot occur any more and pullout will control. Assuming an infinitely strong adhesive, there would be no such lower limit on α_2 and the bond stress, at which splitting occurs can be expressed as:

$$f_{bd, spl1} = \frac{f_{bd}}{1 - 0.15 \cdot \frac{c_d - \phi}{\phi}}$$

For cover dimensions exceeding the range of Eurocode 2, i.e. for $c_d/\phi > 3$ (bonded-in bars only), an adapted factor α_2' is used to create a linear extension of the bond strength function:

$$\alpha_2' = \frac{1}{\frac{1}{0.7} + \delta \cdot \frac{c_d - 3 \cdot \phi}{\phi}}$$

$$f_{bd, spl2} = \frac{f_{bd}}{\max[\alpha_2'; 0.25]}$$

where δ is a factor defining the growth of the linear function for $f_{bd, spl, 2}$; it is calibrated on the basis of tests. In order to avoid unreasonably low values of α_2' , its value is limited to $\alpha_2' \geq 0.25$

Below is a typical design bond stress f_{bd} curve as a function of the minimum edge distance/spacing distance, c_d is shown for a concrete class C20/25 and for a rebar with a diameter of not more than 32mm. In this figure the equivalent design bond stresses according to EC 2 and resulting from the above described definition of α_2 and α_2' are plotted. The design bond strength is defined by an inclined line and it increases with larger values of c_d . The diagram also shows the characteristic value of the bond strength ($f_{bd} \cdot \gamma_c$ where $\gamma_c=1.5$).

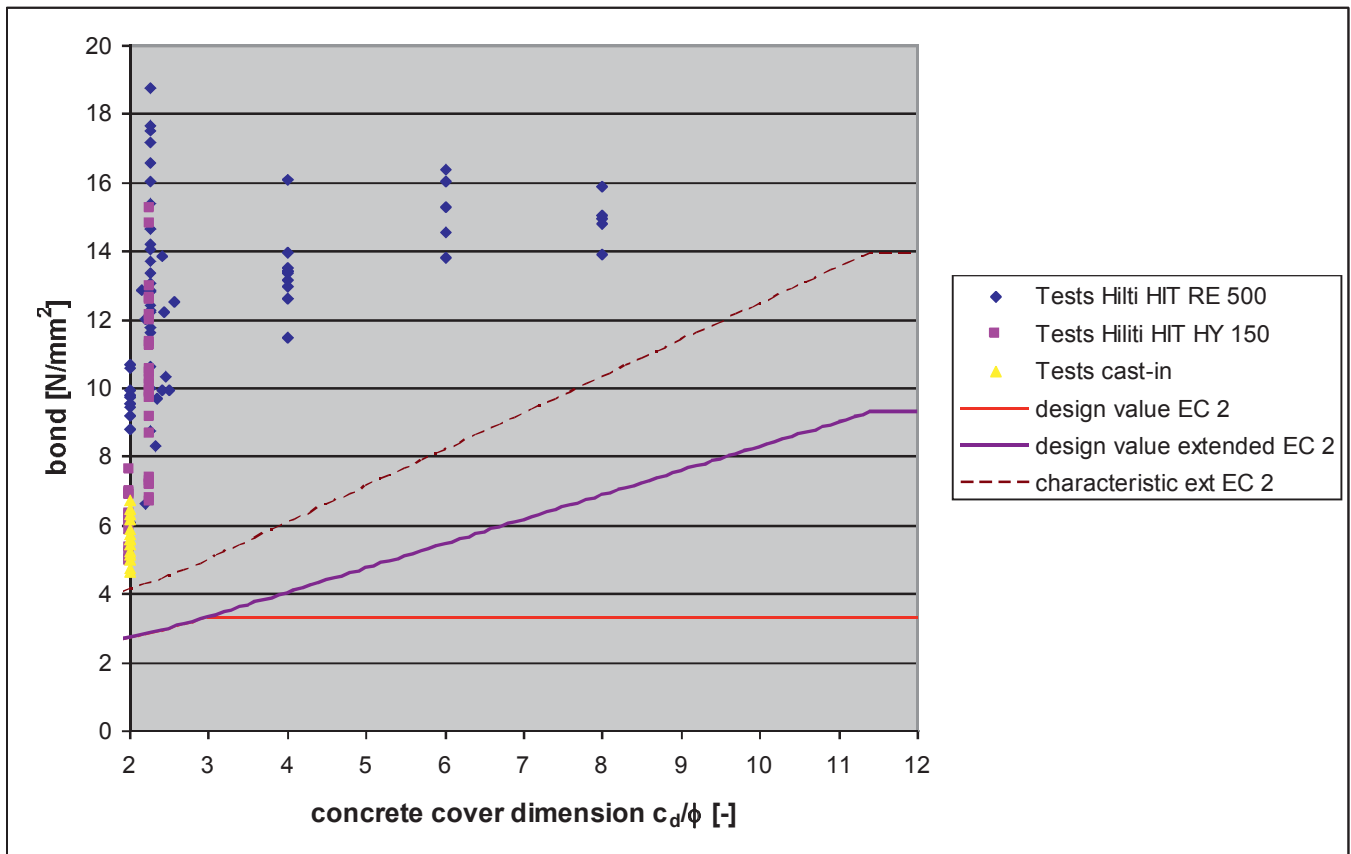

The increase in the design bond stress is limited by the maximum pull-out bond stress, which is a value given by the standards in the case of a cast-in reinforcement. For post-installed reinforcement, the maximum design bond stress is a function of the bonding agent and not necessarily equals that of cast-in bars; it will be taken from the relevant anchor approval. Thus, the limitation for bond failure in the code has been replaced by the specific design bond stress of the bonding agent for the specific application conditions and the splitting function has been adapted according to the tests.

2.3.2 Strut and Tie Model for Frame Nodes

If frame nodes (or moment resisting connections in general) are designed with cast-in reinforcement, they usually require bent bars according to the standard reinforced concrete design rules. Anchoring the reinforcement of moment resisting connections with straight bars would, at least at first sight, result in concrete that is under tension, and therefore in a possible concrete cone failure. As this failure mode is brittle, such an anchorage is not allowed by the standard concrete design rules. In cooperation with the Technical University of Munich, Hilti performed a research programme in order to provide a strut-and-tie model for frame nodes with straight connection bars [6, 7]. The main differences to the standard cast-in solution are that the compression strut is anchored in the bonding area of the straight bar rather than in the bend of the bar and that, therefore, first the inner lever arm inside the node is reduced and second, splitting forces in the transition zone between D- and B-region must be considered.

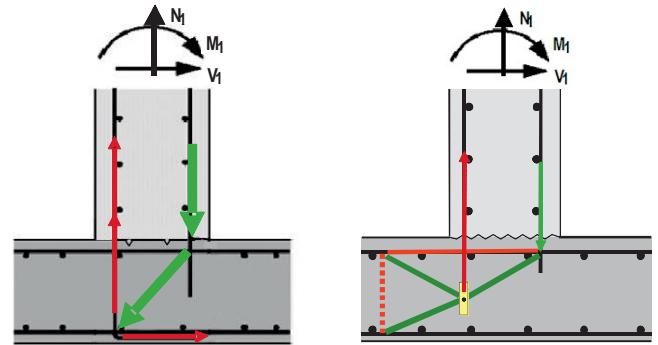

Global Equilibrium of the Node

In order to check the struts and ties inside the node, the reactions N_2 , V_2 , M_2 , N_3 , V_3 , M_3 at the other ends of the node need to be defined. Normally, they result from the structural analysis outside the node region and will be determined by the designer in charge.

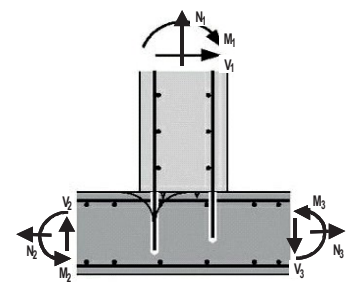

Global equilibrium of the node

Tension in connecting bars

The loading of the wall in the figures results in a tensile force in the reinforcement on the left hand side and in a compression force on the right hand side. Initial tests and computer simulations led to the consideration that the straight bar has a tendency to push a concrete cone against the interface with the wall. Thus the compressive stress in the interface is not concentrated on the outside of the wall, but distributed over a large part of the interface, which leads to a reduced lever arm in the wall section. The recommended reduction factor is 0.85 for opening moments and 1.0 for closing moments.

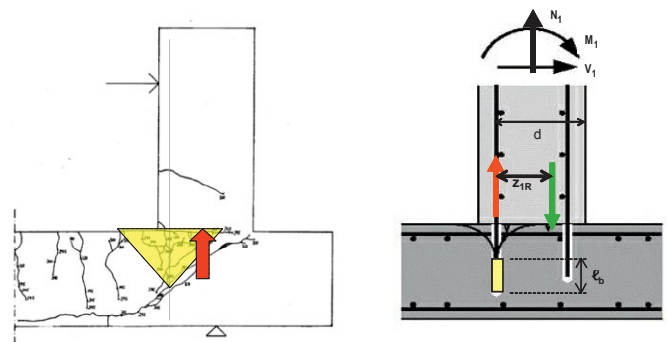

Anchorage length

While the equilibrium inside of frame nodes with cast-in hooked bars can be modeled with the compression strut continuing from the vertical compression force and anchored in the bend at the level of the lower reinforcement, straight bars are anchored by bond stresses at a level above the lower reinforcement.

As bending cracks are expected to occur along the bar from the top of the base concrete, the anchorage zone is developing from the lower end of the bar and its length ℓ_b is that required to develop the steel stress calculated from the section forces M_1 , N_1 and V_1 .

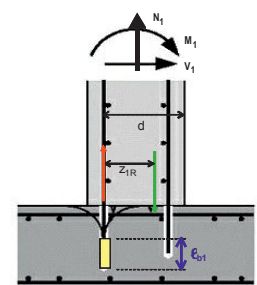

$$\ell_b = \frac{\sigma_{sd} \cdot \phi}{4 \cdot f_{bd}}$$

with σ_{sd} design steel stress in the connection bars [MPa]
 ϕ diameter of the vertical bar [mm]
 f_{bd} design bond strength of cast-in bar to concrete or of the adhesive mortar [MPa]

Installation length

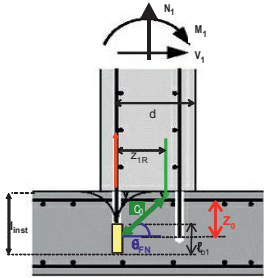

The strut-and-tie model requires that the angle θ between the inclined compression strut C_0 and the horizontal direction is 30° to 60° . For low drill hole lengths the resulting strut angle will be less than 30° . In such situations the design will not work as tests have shown. Also in order to remain as close as possible to the original solution with the bent bar, it is recommended to drill the holes as deep as possible in order to achieve a large strut angle θ_{FN} .

Note that PROFIS Rebar will preferably propose the installation length such that the strut angle θ_{FN} is 60° . In cases where the existing section is too thin for this, it will propose the maximum possible embedment depth which is defined for bonded anchors in ETAG 001,

part 5, section 2.2.2 as

$$l_{inst,max} = h_{member} - \max(2 \cdot d_0; 30\text{mm})$$

with $l_{inst,max}$ maximum possible installation length [mm]
 h_{member} thickness of the existing concrete member [mm]
 d_0 diameter of the drilled hole [mm]

Tension in Existing Reinforcement

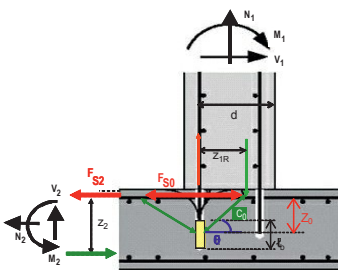

For a drilled hole depth l_{inst} and a concrete cover of the upper reinforcement to the center of the bars of c_s , the lever arm inside z_0 the node is:

$$z_0 = l_{inst} - \frac{\ell_b}{2} - c_s$$

The lever arm inside the node z_0 is smaller than the lever arm of the slab z_2 . The tension in the upper slab reinforcement in the node region, F_{s0} , is higher than the tension calculated for the slab with z_2 ; the tensile resistance of the existing upper reinforcement $A_{s0,prov}$ must therefore be checked separately as follows:

$$F_{s2} = M_2/z_2 + N_2/2 \quad (\text{tension in existing reinforcement outside node area})$$

$$H_{s2} = \left(M_1 + (V_2 + V_3) \cdot \frac{z_1}{2} \right) \cdot \left(\frac{1}{z_0} - \frac{1}{z_2} \right) + V_1 \cdot \left(\frac{z_1}{z_0} - 1 \right) \quad (\text{additional tension in node due to reduced lever arm})$$

$$F_{s0} = F_{s2} + H_{s2} \quad (\text{steel tension in node area})$$

$$A_{s0,rqd} = F_{s0}/(f_{yk}/\gamma_s) \quad (\text{steel area required in existing part for forces from new part})$$

If $A_{s0,prov} \geq A_{s0,rqd}$ the reinforcement of the existing part is sufficient, provided that the forces from the new part are the only load on the section. This is the analysis obtainable from PROFIS Rebar.

As mentioned further above, a more sophisticated check needs to be made if there are also other loads in the system. Basically it would mean replacing F_{s2} as evaluated by under "global equilibrium" above by that evaluated in the complete static design.

The shallower the embedment of the post-installed vertical bar is, the more the moment resistance of the slab in the node region is reduced compared to a node with hooked bar. For this reason, it is also recommended to provide deep embedment of the connecting bars rather than trying to optimize mortar consumption by trying to recommend the shortest possible embedment depth.

Concrete Compressive Strut

The strut-and-tie model assumes that the compression strut C_0 is anchored at the center of the anchorage zone and that its thickness corresponds to the length of the anchorage zone ℓ_b .

$$F_{c0} = \frac{M_1 + (V_2 + V_3) \cdot z_1 / 2}{z_0} \quad (\text{horizontal component of concrete strut force})$$

$$D_0 = F_{c0} / \cos \theta_{FN} \quad (\text{concrete force in direction of strut})$$

$$\sigma_{Rd,max} = v' \cdot k_2 \cdot \alpha_{cc} \cdot f_{ck} / \gamma_c \quad (\text{reduced concrete strength in tension-compression node according to ENV1992-1-1, 4.5.4(4b). Standard parameters: } v'=1-f_{ck}/250; k_2=0.85; \alpha_{cc}=1.0; \gamma_c=1.5, \text{ subject to variations in National Application Documents})$$

$$D_{0,R} = \sigma_{Rd,max} \cdot \ell_b \cdot w \cdot \cos \theta_{FN} \quad (\text{resistance of concrete in strut direction, } w=\text{width of section})$$

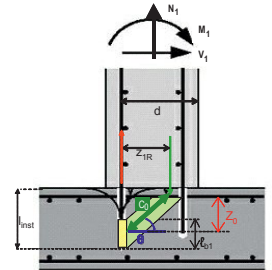

If $D_{0R} \geq D_0$ the concrete strut can take up the loads introduced from the new section.

Splitting of Concrete in Transition Area

On the left hand side of the anchorage zone, the compression force is continuing through additional struts to the tension and compression zones of the B-region of the slab where the equilibrium of the horizontal forces is given. The vertical components of these struts are taken up by tensile stresses in the concrete. Normally there is no vertical reinforcement in the slab to take up the tension force. The loads and thermal solicitations of a slab do not lead to horizontal cracking; therefore it is possible to attribute the tension force to the tensile capacity of the concrete. On the safe side, the maximum splitting stress has been taken as that caused by a concentrated load C_0 on the center of the anchorage zone. It has been shown that the occurring splitting stress $\max \sigma_{sp}$ can be calculated as

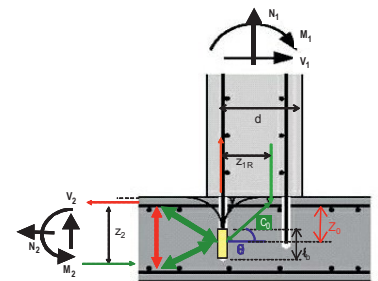

$$\max \sigma_{sp} = \left(M_1 + \frac{(V_2 + V_3) \cdot z_1}{2} \right) \cdot \left(1 - \frac{z_0}{z_2} \right) \cdot \left(1 - \frac{\ell_b}{2 \cdot z_2} \right) \cdot \left(\frac{2.42}{b \cdot z_2^2} \right) \leq f_{ct}$$

- with: M_1, V_2, V_3 : external forces on node according to figure 5
 z_2 : inner lever arm of slab section outside node region
 b : width of the wall section
 $f_{ctd} = \alpha_{ct} \cdot 0.7 \cdot 0.3 \cdot f_{ck}^{2/3} / \gamma_c$: tensile strength of concrete (Standard value in EC2: $\alpha_{ct}=1.0$, subject to variations in National Application Documents)

If the calculated maximum splitting stress is smaller than the tensile strength of the concrete f_{ct} , then the base plate can take up the splitting forces without any additional shear reinforcement.

2.3.3 Design Examples

a) End support of slab, simply supported

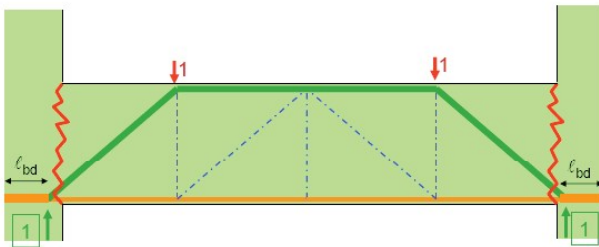
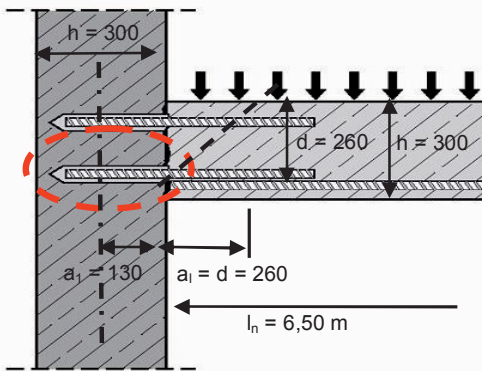

slab: $l_n = 4,50\text{m}$, $Q_k = 20\text{ kN/m}^2$, $h = 300\text{ mm}$, $d = 260\text{ mm}$

wall: $h = 300\text{ mm}$

Concrete strength class: C20/25, dry concrete

Reinforcement: $f_{yk} = 500\text{ N/mm}^2$, $\gamma_s = 1.15$

Loads: $G_k = 25\text{ kN/m}^3 \cdot h = 7.5\text{ kN/m}^2$;
 $S_d = (1.50 \cdot Q_d + 1.35 \cdot G_k) = 40.1\text{ kN/m}^2$

Structural analysis (design forces):

$$M_{Ed} = S_d \cdot l_n^2 / 8 = 102\text{ kNm/m}$$

$$V_{Ed} = S_d \cdot l_n / 2 = 90.3\text{ kN/m}$$

Bottom reinforcement required at mid span:

$$A_{s,rqd,m} = (M_{sd} \cdot \gamma_s) / (0.9 \cdot d \cdot f_{yk}) = 998\text{ mm}^2/\text{m}$$

reinforcement provided at mid span: $\varnothing 16$, $s = 200\text{ mm}$

$$A_{s,prov,m} = 1005\text{ mm}^2/\text{m}$$

Bottom reinforcement at support:

Tension force to be anchored: $F_{Ed} = |V_{Ed}| \cdot a_1 / (0.9d) = 100\text{ kN/m}$ (Clause 9.2.1.4(2), EC2: EN 1992-1-1:2004)

Steel area required: $A_{s,rqd} = F_{Ed} \cdot \gamma_s / f_{yk} = 231\text{ mm}^2/\text{m}$

Minimum reinforcement to be anchored at support:

$A_{s,min} = k_c \cdot k \cdot f_{ct,eff} \cdot A_s / \sigma_s = 0,4 \cdot 1 \cdot 2,2 \cdot 150 \cdot 1000 / 500 = 264\text{ mm}^2/\text{m}$ (Clause 7.3.2(2), EC2: EN 1992-1-1:2011)

$A_{s,min} = 0,5 \cdot A_{s,rqd,m} = 0,50 \cdot 988 = 499\text{ mm}^2/\text{m}$ (Clause 9.3.1.2(1), EC2: EN 1992-1-1:2011)

$A_{s,min} = 0,25 \cdot A_{s,prov,m} = 0,25 \cdot 1010 = 251\text{ mm}^2/\text{m}$ (Clause 9.2.1.4(1), EC2: EN 1992-1-1:2011)

Decisive is $499\text{ mm}^2/\text{m} \Rightarrow$ reinforcement provided: $\varnothing 12$, $s = 200\text{ mm} \Rightarrow A_{s,prov} = 565\text{ mm}^2/\text{m}$;

Installation by hammer drilling; Hilti HIT-RE 500

Minimum anchorage length

$\sigma_{sd} = (A_{s,rqd} / A_{s,prov}) \cdot (f_{yk} / \gamma_s) = (23 / 565) \cdot (500 / 1,15) = 177\text{ N/mm}^2$

$f_{bd,EC2} = 2,3\text{ N/mm}^2$ (EC 2 for minimum length. see tech. data, sect. 6)

$\ell_{b,rqd} = (\phi / 4) \times (\sigma_{sd} / f_{bd}) = (12 / 4) \times (177 / 2.3) = 231\text{ mm}$

$\ell_{b,min} = \max \{0.3 \ell_{b,rqd}; 10\phi; 100\text{mm}\} = 120\text{ mm}$ (Clause 8.4.4(1), EC2: EN 1992-1-1:2011)

Development length:

Cover dimension: $c_d = (s - \phi) / 2 = 94\text{ mm}$

Confinement $c_d / \phi = 94 / 12 = 7.8$

Splitting bond strength for $c_d/\phi > 3$:

$$\alpha_2' = \frac{1}{\frac{1}{0.7} + \delta \cdot \frac{c_d - 3\phi}{\phi}} = \frac{1}{\frac{1}{0.7} + 0.306 \cdot \frac{94 - 3 \cdot 12}{12}} = 0.344$$

$$f_{bd,spl,2} = \frac{f_{bd,EC2}}{\max(\alpha_2'; 0.25)} = \frac{2.3}{0.344} = 6.7 \text{ N/mm}^2$$

Pullout bond strength: $f_{bd,p} = 8.6 \text{ N/mm}^2$ (see tech. data, sect. 6)

Applicable design bond strength: $f_{bd} = \min(f_{bd,spl}; f_{bd,p}) = 6.7 \text{ N/mm}^2$

Design development length: $\ell_{bd} = (\phi/4) \cdot (\sigma_{sd}/f_{bd}) = 80 \text{ mm}$

Minimum length controls \rightarrow drill hole length $\ell_{ef} = 120 \text{ mm}$

Top reinforcement at support:

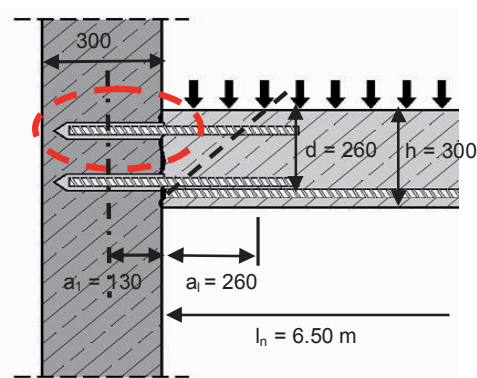

Minimum reinforcement:

- a) 25% of bottom steel required at mid-span
{Clause 9.3.1.2(2), EC2: EN 1992-1-1:2004}
 $A_{s,req} = 0,25 \cdot 988 = 247 \text{ mm}^2/\text{m}$
- b) requirement for crack limitation :
{Clause 7.3.2(2), EC2: EN 1992-1-1:2004}
 $A_{s,min} = 0,4 \cdot 1 \cdot 2,2 \cdot 150 \cdot 1000 / 435 = 303 \text{ mm}^2/\text{m}$

Decisive is $303 \text{ mm}^2/\text{m}$

\Rightarrow reinforcement provided: $\varnothing 10, s = 200 \text{ mm}; A_{s,prov} = 393 \text{ mm}^2/\text{m}$

Design stress in bar: $\sigma_{sd} = f_{yd} \cdot A_{s,min} / A_{s,prov} = 335 \text{ N/mm}^2$

Minimum anchorage length

$\sigma_{sd} = (A_{s,rqd} / A_{s,prov}) \cdot (f_{yk}/\gamma_s) = (23 / 565) \cdot (500/1,15) = 335 \text{ N/mm}^2$

$f_{bd,EC2} = 2,3 \text{ N/mm}^2$ (EC 2 for minimum length. see tech. data, sect. 6)

$\ell_{b,rqd} = (\phi / 4) \times (\sigma_{sd} / f_{bd}) = (10 / 4) \times (335 / 2.3) = 364 \text{ mm}$

$\ell_{b,min} = \max \{0.3\ell_{b,rqd}; 10\phi; 100\text{mm}\} = 110 \text{ mm}$ (Clause 8.4.4(1), EC2: EN 1992-1-1:2011)

Development length:

Cover dimension: $c_d = (s - \phi)/2 = 95 \text{ mm}$

Confinement $c_d/\phi = 95/10 = 9.5$

Splitting bond strength for $c_d/\phi > 3$:

$$\alpha_2' = \frac{1}{\frac{1}{0.7} + \delta \cdot \frac{c_d - 3\phi}{\phi}} = \frac{1}{\frac{1}{0.7} + 0.306 \cdot \frac{95 - 3 \cdot 10}{10}} = 0.293$$

$$f_{bd,spl,2} = \frac{f_{bd,EC2}}{\max(\alpha_2'; 0.25)} = \frac{2.3}{0.293} = 7.9 \text{ N/mm}^2$$

Pullout bond strength: $f_{bd,p} = 8.6 \text{ N/mm}^2$ (see tech. data, sect. 6)

Applicable design bond strength: $f_{bd} = \min(f_{bd,spl}; f_{bd,p}) = 7.9 \text{ N/mm}^2$

Design development length: $\ell_{bd} = (\phi/4) \cdot (\sigma_{sd}/f_{bd}) = 97 \text{ mm}$

Minimum length controls → drill hole length $l_{ef} = 110 \text{ mm}$

Therefore, drill hole length $l_{ef} = 110 \text{ mm}$

If wet diamond core drilling is used:

$l_{b,min} = \max \{0,3l_{b,req}; 10\phi; 100\text{mm}\} \cdot 1.5 = 180 \text{ mm}$ (as wet diamond core drilling is used, the minimum values according do EC2 have to be multiplied by 1.5, see tech data)

-> in this case the minimum length will control, drill hole length $l_{ef} = 180 \text{ mm}$ for upper and lower layers

b) Wall bending connection

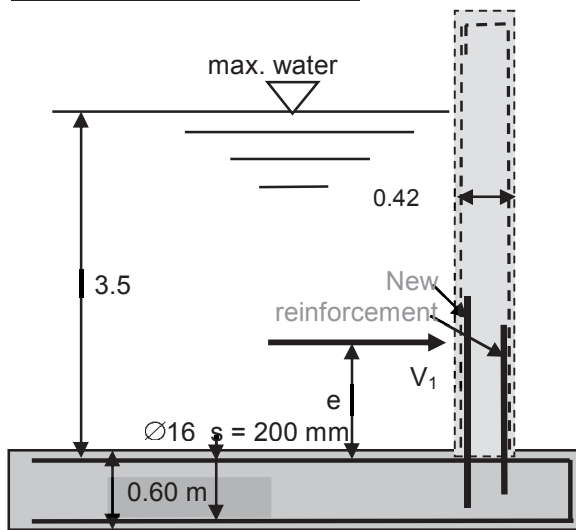

Note: transverse reinforcement not

Geometry:

$h_1 = 420 \text{ mm}; h_2 = h_3 = 600 \text{ mm};$
 $d_1 = 380 \text{ mm}; d_2 = d_3 = 560 \text{ mm};$
 $z_1 = 360 \text{ mm}; z_2 = z_3 = 520 \text{ mm}$
 $A_{s0} = A_{s2} = A_{s3} = 1005 \text{ mm}^2/\text{m} (\text{Ø}16 \text{ s} = 200 \text{ mm})$
 $c_s = h_2 - d_2 = 40 \text{ mm}$

Material:

Concrete: C20/25 (new and existing parts), $\gamma_s = 1.5$
 Steel grade: 500 N/mm², $\gamma_s = 1.15$
 Safety factor for variable load: $\gamma_Q = 1.5$
 HIT-RE 500-SD (temperature range I)

Acting loads:

$$V_{1d} = \gamma_Q \cdot p \cdot h^2 / 2 = 1.4 \cdot 10 \cdot 3.5^2 / 2 = 92 \text{ kN/m}$$

$$e = h / 3 = 3.5 / 3 = 1.17 \text{ m}$$

$$M_{1d} = V_{1d} \cdot e = 92 \cdot 1.17 = 107 \text{ kNm/m}$$

Force in post-installed reinforcement

$$z_{1r} = 0.85 \cdot z_1 = 0.85 \cdot 360 = 306 \text{ mm} \quad (\text{opening moment} \rightarrow \text{reduced inner lever arm})$$

$$F_{s1d} = M_{1d} / z_{1r} = 107 / 0.306 = 350 \text{ kN/m}$$

$$A_{s1,rqd} = F_{s1d} / (f_{yk} / \gamma_{Ms}) = 350 \cdot 1000 / (500 / 1.15) = 805 \text{ mm}^2/\text{m}$$

Select $\phi 12 \text{ mm}$, spacing $s_1 = 125 \text{ mm} \rightarrow A_{s1,prov} = 905 \text{ mm}^2$

\rightarrow drilled hole diameter: $d_0 = 16 \text{ mm}$

Stress in bar: $\sigma_{sd} = F_{s1d} / A_{s1,prov} = 386 \text{ N/mm}^2$

anchorage length

$$f_{bd,EC2} = 2.3 \text{ N/mm}^2 \quad (\text{EC 2 for minimum length})$$

$$\ell_{b,rqd,EC2} = (\phi/4) \cdot (\sigma_{sd} / f_{bd,EC2}) = 504 \text{ mm}$$

$$\ell_{b,min} = \max \{0.3 \ell_{b,rqd,EC2}; 10\phi; 100 \text{ mm}\} = 151 \text{ mm}$$

$$f_{bd,b} = 8.3 \text{ N/mm}^2 \quad (\text{see tech. data, sect. 6})$$

$$c_d = s_1/2 - \phi/2 = 56.5 \text{ mm} > 3\phi$$

$$\alpha_2' = \frac{1}{\max \left[\frac{1}{0.7} + \delta \cdot \frac{c_d - 3\phi}{\phi}; 0.25 \right]} = 0.512$$

$$f_{bd,spl2} = \frac{f_{bd}}{\max [\alpha_2'; 0.25]} = 4.5 \text{ N/mm}^2$$

$$f_{bd} = \min \{f_{bd,b}; f_{bd,spl}\} = 4.5 \text{ N/mm}^2$$

$$\ell_{b1} = \max \{(\phi/4) \cdot (\sigma_{sd} / f_{bd}); \ell_{b,min}\} = 258 \text{ mm}$$

Drilled hole length

$$l_{inst,max} = h_2 - \max\{2d_0; 30\text{mm}\} = 568 \text{ mm} \quad (\text{maximum possible hole length})$$

$$l_{inst,60} = c_s + z_{1R} \cdot \tan 60^\circ + l_{b1} / 2 = 672 \text{ mm} \quad (\text{hole length corresponding to } \theta=60^\circ)$$

$$l_{inst,60} > l_{inst,max} \rightarrow \text{select hole length } l_{inst} = l_{inst,max} = 568 \text{ mm}$$

$$\text{Strut angle with } l_{inst,max}: \tan \theta = (l_{inst,max} - c_s - l_{b1}/2) / z_{1R} \rightarrow \theta_{FN} = 53^\circ$$

check: $\theta > 30^\circ \rightarrow \text{ok}$

Reaction in Foundation:

$$-M_{2d} = M_{1d} + V_{1d} \cdot z_2 / 2 = 107 + 0.25 \cdot 92 = 131 \text{ kNm/m}$$

$$N_{2d} = -V_{1d} = -92 \text{ kN/m}$$

$$M_{s3} = 0; V_{2d} = V_{3d} = 0; N_1 = N_3 = 0$$

Check of foundation reinforcement

$$F_{s2d} = M_{2d} / z_2 + N_{2d} / 2 = 298 \text{ kNm/m} \quad (\text{tension outside node area})$$

$$z_0 = l_{inst} - c_s - l_{b1} / 2 = 568 - 40 - 258/2 = 399 \text{ mm} \quad (\text{lever arm in node area})$$

$$H_{s2d} = M_{1d} \cdot (1/z_0 - 1/z_2) + V_{1d} \cdot (z_1/z_0 - 1) = 53 \text{ kNm/m} \quad (\text{additional force in node area})$$

$$F_{s2d,node} = F_{s2d} + H_{s2d} = 351 \text{ kNm/m} \quad (\text{tension in node area})$$

$$A_{s2,rqd} = F_{s2d,node} / (f_{yk} / \gamma_{Ms}) = 351 \cdot 1000 / (500 / 1.15) = 808 \text{ mm}^2/\text{m}$$

$$A_{s2} > A_{s2,rqd} \rightarrow \text{ok} \quad (A_{s2} \text{ is given})$$

Check concrete compressive strut

$$F_{c0d} = M_{1d} / z_0 = 268 \text{ kN/m}$$

$$D_{0d} = F_{c0d} / \cos \theta_{FN} = 441 \text{ kN/m}$$

$$\alpha_{ct} = 1.0 \quad (\text{EC2: EN 1992-1-1:2004, 3.1.6(1)})$$

$$v' = 1 - f_{ck} / 250 = 0.92 \quad (\text{EC2: EN 1992-1-1:2004, 6.5.2(2)})$$

$$k_2 = 0.85 \quad (\text{EC2: EN 1992-1-1:2004, 6.5.4(4b)})$$

$$D_{0Rd} = \alpha_{ct} \cdot v' \cdot k_2 \cdot f_{ck} / \gamma_c \cdot l_{b1} \cdot \cos \theta_{FN} = 1639 \text{ kN/m}$$

$$D_{0Rd} > D_{0d} \rightarrow \text{ok}$$

Check concrete splitting in plane of foundation

$$\alpha_{ct} = 1.0 \quad (\text{EC2: EN 1992-1-1:2004, 3.1.6(2)})$$

$$f_{ctk,0.05} = \alpha_{ct} \cdot 0.7 \cdot 0.3 \cdot f_{ck}^{2/3} / \gamma_c = 1.03 \text{ N/mm}^2 \quad (\text{table 3.1, EC2: EN 1992-1-1:2004})$$

$$M_{sp,d} = F_{c0d} \cdot z_0 \cdot (1 - z_0/z_2) \cdot (1 - l_{b1}/(2z_2)) = 1.87 \cdot 10^7 \text{ Nmm/m}$$

$$W_{sp} = 1000\text{mm} \cdot z_2^2 / 2.41 = 1.12 \cdot 10^8 \text{ mm}^3/\text{m}$$

$$\max \sigma_{sp} = M_{sp,d} / W_{sp} = 0.17 \text{ N/mm}^2$$

$$f_{ctk,0.05} > \max \sigma_{sp} \rightarrow \text{ok}$$

2.4 Load Case Fire

The bond strength in slabs under fire has been evaluated in tests and is certified by reports of the Technical University of Brunswick, Germany. The conformity with the German standards is confirmed in DIBt German national approvals, the one with British Standard BS8110:1997 in the Warrington Fire Report. French cticm Approvals also give data for beams. These documents are downloadable from the Intranet for the different adhesive mortars.

There are two types of design tables corresponding to the basic fire situations “parallel” and “anchorage”.

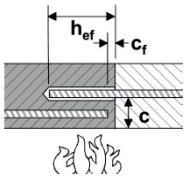

In the fire situation “parallel” the only parameter is the clear distance from the fire exposed concrete surface to the perimeter of the bar (“clear concrete cover c”). From this parameter, one can directly read the bond strength of the adhesive for specific fire durations.

In fire design, it influences like is sufficient to anchorage load under fire

$\tau_{Rd,fi}$

| Clear concrete cover c [mm] | Max. bond stress, τ_c [N/ | | | |
|--------------------------------|--------------------------------|-------|-------|-------|
| | F30 | F60 | F90 | F120 |
| 10 | 0 | 0 | 0 | 0 |
| 20 | 0,494 | 0 | 0 | 0 |
| 30 | 0,665 | 0 | 0 | 0 |
| 40 | 0,897 | 0,461 | 0 | 0 |
| 50 | 1,200 | 0,623 | 0 | 0 |
| 60 | 1,630 | 0,806 | 0,513 | 0 |
| 70 | 2,197 | 1,043 | 0,655 | 0,487 |
| 80 | 2,962 | 1,351 | 0,835 | 0,614 |
| 90 | 3,992 | 1,748 | 1,065 | 0,775 |
| 100 | 5,382 | 2,263 | 1,358 | 0,977 |
| 110 | 7,255 | 2,930 | 1,733 | 1,233 |
| 120 | 9,780 | 3,792 | 2,210 | 1,556 |
| 130 | | 4,909 | 2,818 | 1,963 |
| 140 | 1,00 | 6,355 | 3,594 | 2,477 |
| 150 | | 8,226 | 4,584 | 3,125 |

is not necessary to re-calculate bond condition or alpha factors. It prove that the calculated splice or length is sufficient to transmit the with the given fire bond strength

$$F_{fire} = f_{bd,fi} \cdot \phi \cdot \pi \cdot h_{ef}$$

Fire design

table for situation „parallel“

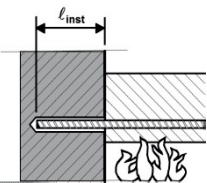

In the fire situation “anchorage” the tables directly show the fire resistance as a force [kN] for given diameters, embedment depths and fire durations.

The tables mention a maximum steel force in fire. It is important to know that this value is derived for a specific assumed value of $f_{yk,fi}$ (see sect. 2.1.2) and will be different for other values of $f_{yk,fi}$. In the published tables

| Bar \varnothing [mm] | Drill hole \varnothing [mm] | Max. $F_{s,T}$ [kN] | ℓ_{inst} [mm] | F30 [kN] | F60 [kN] | F90 [kN] |
|---------------------------|----------------------------------|------------------------|-----------------------|-------------|-------------|-------------|
| 8 | 12 | 16,2 | 80 | 2,18 | 0,73 | 0,24 |
| | | | 120 | 8,21 | 2,90 | 1,44 |
| | | | 170 | 16,2 | 9,95 | 5,99 |
| | | | 210 | | 16,2 | 13,01 |
| | | | 230 | | | 16,2 |
| | | | 250 | | | |
| 10 | 14 | 25,3 | 100 | 5,87 | 1,95 | 0,84 |
| | | | 150 | 16,86 | 8,06 | 4,45 |
| | | | 190 | 25,3 | 16,83 | 11,86 |
| | | | 230 | | 25,3 | 20,66 |
| | | | 260 | | | 25,3 |
| | | | 280 | | | |
| | | | 320 | | | |
| | | | 120 | 12,32 | 4,35 | 2,16 |
| | | | 180 | 28,15 | 17,56 | 11,59 |

$f_{yk,fi}=322N/mm^2$ was normally assumed; if this value was given as e.g. $f_{yk,fi}=200N/mm^2$ the maximum force for bar diameter 8mm in the table below would be Max. $F'_{s,T}=10.1kN$. This would then imply that in the columns on the right side, all values would be cut off at 10.1kN, i.e. the values 16.2 or 13.01 would not appear any more.)That means that there is no such thing as a given maximum force in fire.

Intermediate values between those given in the fire design tables may be interpolated linearly. Extrapolating is not permitted.

$$R_{fire} = \phi \cdot \pi \cdot \sum_{i=1}^n \tau_{crit,\theta} \cdot \ell_i$$

Fire design table for situation „anchorage“

2.5 Fatigue of bonded-in reinforcement for joints

General notes

For load bearing elements which are subjected to considerable cyclic stress the bonded-in connections should be designed for fatigue. In that case evidence for fatigue of reinforcing steel bars, concrete and bond should be provided separately.

For simple cases it is reasonable to use simplified methods on the safe side.

The partial safety factors for loads are specified in the code for reinforced concrete.

The partial safety factors for material are specified in Table 4.3.

Table 4.3: Partial safety factors for materials subjected to cyclic loading

| Evidence for | concrete | bond | reinforcing bars (steel) |
|-----------------------|----------|------|--------------------------|
| Partial safety factor | 1.5 | 1.8 | 1.15 |

Fatigue of reinforcing bars (steel)

The resistance for fatigue of reinforcing bars (steel) is specified in the actual code for reinforced concrete. The behaviour of the steel of reinforcing bars bonded-in by means of HIT-Rebar is at least as good as cast-in place reinforcement.

Fatigue of bond and concrete (simplified approach)

As a simple and conservative approach on the safe side evidence for fatigue is proven if the following equation is valid:

$$F_{Sd,fat} \leq N_{Rd} \cdot f_{fat}$$

where:

$F_{Sd,fat}$ Design value of the anchorage force for the ruling loading model for fatigue.

N_{Rd} Design resistance for static load of the anchorage (bond and concrete).

f_{fat} Reduction factor for fatigue for bond and concrete: $f_{fat} = 0.5$

If max/min of cycles is known, reduction factors are shown in Figure 4.13.

Diagram for a simplified approach with $2 \cdot 10^6$ cycles (Weyrauch diagram)

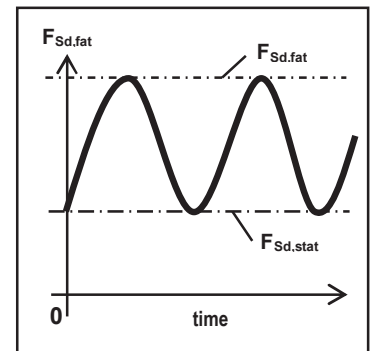
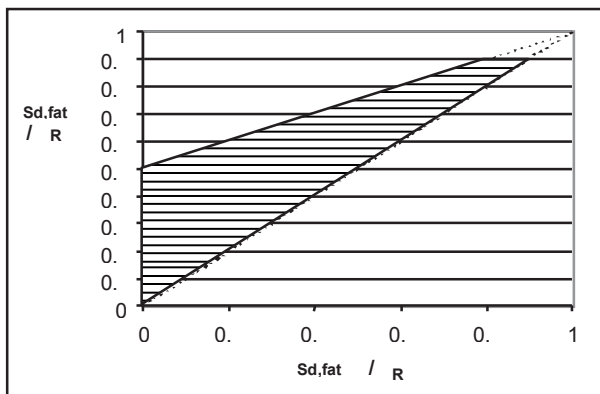

Reduction factors for fatigue for bond and concrete

If the simplified method is not satisfying, additional information using the "Woehler" - lines is available.

Ask Hilti Technical Service for the Hilti Guideline: TWU-TPF 06a/02 HIT-Rebar: Fatigue.

Design Approach

Steel resistance:

The steel resistance under fatigue load is calculated from the part of the load which is permanent, the allowable stress variation and the steel yield strength. The safety factors are the same as those used for static design (taken from ENV 1992-2-2:1996, sect. 4.3.7.2).

$\Delta\sigma_{s,max}$ = ... maximum allowable stress variation, usually given by codes, e.g. ENV 1992-2-2:1996,

sect. 4.3.7.5: $\Delta\sigma_{s,max} = 70N/mm^2$

P percentage of the load which is permanent: $0 \leq P \leq 100$

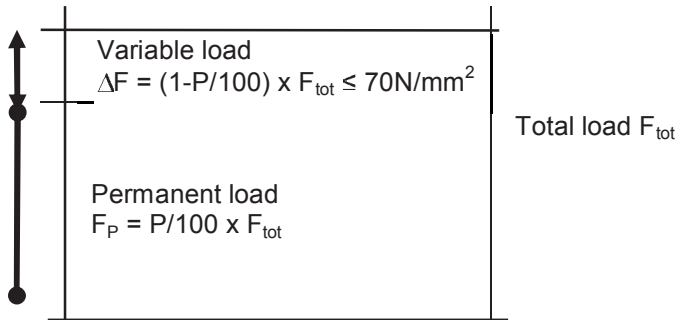

The reduction factor on steel resistance due to dynamic loading is then:

$$f_{red,s,dyn} = \frac{\min(f_{yk}; \frac{70}{1-P/100})}{f_{yk}}$$

And the steel strength taken into account for fatigue loading is

$$\sigma_{s,max,dyn} = f_{red,s,dyn} \cdot f_{yk}$$

Concrete Resistance

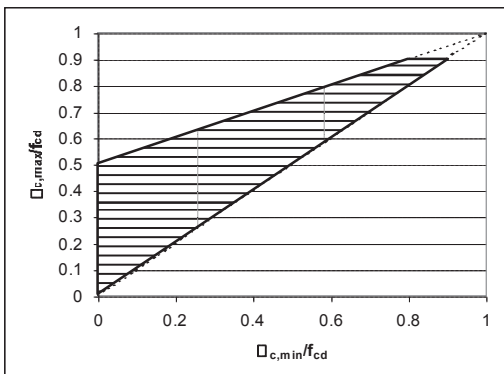

The concrete resistance calculated for static loading is reduced by a reduction factor for fatigue loads, $f_{red,c,dyn}$, which is applied to all types of concrete failure, i.e. splitting, shear in uncracked and shear in cracked concrete. This factor is calculated from the Weyrauch diagram of Eurocode 2 (ENV 1992-2-2:1996, section 4.3.7.4):

$$f_{red,c,dyn} = 0.5 + 0.45 \cdot \frac{P}{100} \leq 0.9$$

For $P=100$ (only permanent loads), $f_{red,c,dyn}$ is, of course 1.0, but as soon as $P < 100$, $f_{red,c,dyn} \leq 0.9$.

Bond Resistance

The bond resistance calculated for static loading is reduced by a reduction factor for fatigue loads, $f_{red,b,dyn}$. This factor is calculated from the Weyrauch diagram based on in-house testing and literature reviews [8]. It has to be chosen between two formulas depending on the situation.

a) in general: $f_{red,b,dyn} = 0.63 + 0.37 \cdot \frac{P}{100} \leq 0.9$

b) HIT-RE 500 in diamond drilled, water saturated hole: $f_{red,b,dyn} = 0.53 + 0.47 \cdot \frac{P}{100} \leq 0.9$

For $P=100$ (only permanent loads), $f_{red,c,dyn}$ is, of course 1.0, but as soon as $P<100$, $f_{red,c,dyn} \leq 0.9$.

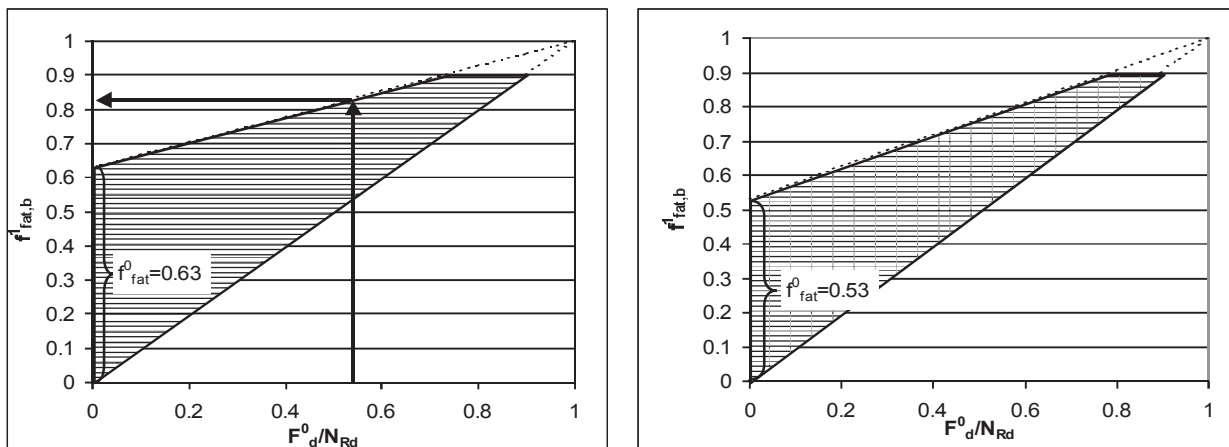

2.6 Seismic design of structural post-installed rebar

An increasing population density, the concentration of valuable assets in urban centers and society's dependence on a functioning infrastructure demand a better understanding of the risks posed by earthquakes. In several areas around the globe, these risks have been reduced through appropriate building codes and state of the art construction practices. The development of pre-qualification methods to evaluate building products for seismic conditions additionally contributes to safer buildings for generations to come.

Approval DTA 3/10-649 [10] delivered by CSTB, a member of EOTA, recognizes Hilti HIT-RE 500-SD injectable mortar as a product qualified for structural rebar applications in seismic zones. This national approval requires that qualified products have an ETA approval for rebar, an ETA approval for anchorage in cracked concrete, as well as an ICC-ES pre-qualification for seismic conditions.

The design procedure is fully details in the approval and, in addition to detailing rules of EC2/rebar ETA, consider the following detailing rules of EN1998-1:2004 (Eurocode 8) [11]:

- max $f_{yk} = 500 \text{ N/mm}^2$
- restricted concrete strengths range: C20/25 to C45/55
- only ductile reinforcement (class C)
- no combination of post-installed and e.g. bent connection bars to ensure displacement compatibility
- columns under tension in critical (dissipation) zones: increase l_{bd} and l_0 , respectively, by 50%
- specific bond strength $f_{bd,seism}$ presented in the following table

By applying engineering judgment, engineers can use this French application document when designing seismic structural post-installed rebar connections. This mentioned practice is presently the only available and fully operational code based procedure in Europe and can as such be considered state-of-the-art.

2.7 Corrosion behaviour

The Swiss Association for Protection against Corrosion (SGK) was given the assignment of evaluating the corrosion behaviour of fastenings post-installed in concrete using the Hilti HIT-HY 200 and Hilti HIT-RE 500 injection systems.

Corrosion tests were carried out. The behaviour of the two systems had to be evaluated in relation to their use in field practice and compared with the behaviour of cast-in reinforcement. The SGK can look back on extensive experience in this field, especially on expertise in the field of repair and maintenance work.

The result can be summarized as follows:

Hilti HIT-HY 200

- The Hilti HIT-HY 200 systems in combination with reinforcing bars can be considered resistant to corrosion when they are used in sound, alkaline concrete. The alkalinity of the adhesive mortar safeguards the initial passivation of the steel. Owing to the porosity of the adhesive mortar, an exchange takes place with the alkaline pore solution of the concrete.
- If rebars are bonded-in into chloride-free concrete using this system, in the event of later chloride exposure, the rates of corrosion are about half those of rebars that are cast-in.
- In concrete containing chlorides, the corrosion behaviour of the system corresponds to that of cast-in rebars. Consequently, the use of unprotected steel in concrete exposed to chlorides in the past or possibly in the future is not recommended because corrosion must be expected after only short exposure times.

Hilti HIT-RE 500 + Hilti HIT-RE 500-SD

- If the Hilti HIT-RE 500 system is used in corrosive surroundings, a sufficiently thick coat of adhesive significantly increases the time before corrosion starts to attack the bonded-in steel.
- The HIT-RE 500 system may be described as resistant to corrosion, even in concrete that is carbonated and contains chlorides, if a coat thickness of at least 1 mm can be ensured. In this case, the unprotected steel in the concrete joint and in the new concrete is critical.
- If the coat thickness is not ensured, the HIT-RE 500 system may be used only in sound concrete. A rebar may then also be in contact with the wall of the drilled hole. At these points, the steel behaves as though it has a thin coating of epoxy resin.
- In none of the cases investigated did previously rusted steel (without chlorides) show signs of an attack by corrosion, even in concrete containing chlorides.
- Neither during this study an acceleration of corrosion was found at defective points in the adhesive nor was there any reference to this in literature. Even if a macro-element forms, the high resistance to it spreading inhibits a locally increased rate of corrosion.
- Information in reference data corresponds with the results of this study.

3 Design Programme PROFIS Rebar

The PROFIS Rebar™ design programme allows rapid and safe design of post-installed reinforcement connections.

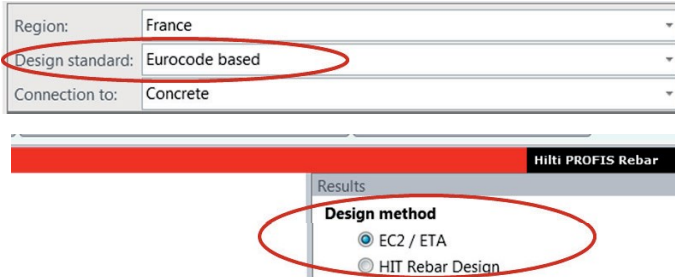

When a new project is opened, the user selects between the design methods “Eurocode based” and “ACI based” design methods. After this, the necessary data concerning existing structure, new rebars and loads have to be defined.

The results pane to the right of the drawing lets the user switch between the methods “EC2 / ETA” (see section 2.2) and “HIT rebar design” (see section 2.3).

In the left hand ribbon of the screen, the user can then select the adhesive mortar to be used and either the bar size or the spacing for top and bottom layers. Based on the input data, the program calculates the section forces in steel and concrete as well as the position of the neutral axis. (Elastic-plastic behaviour of the steel is assumed, strain hardening is not taken into account.)

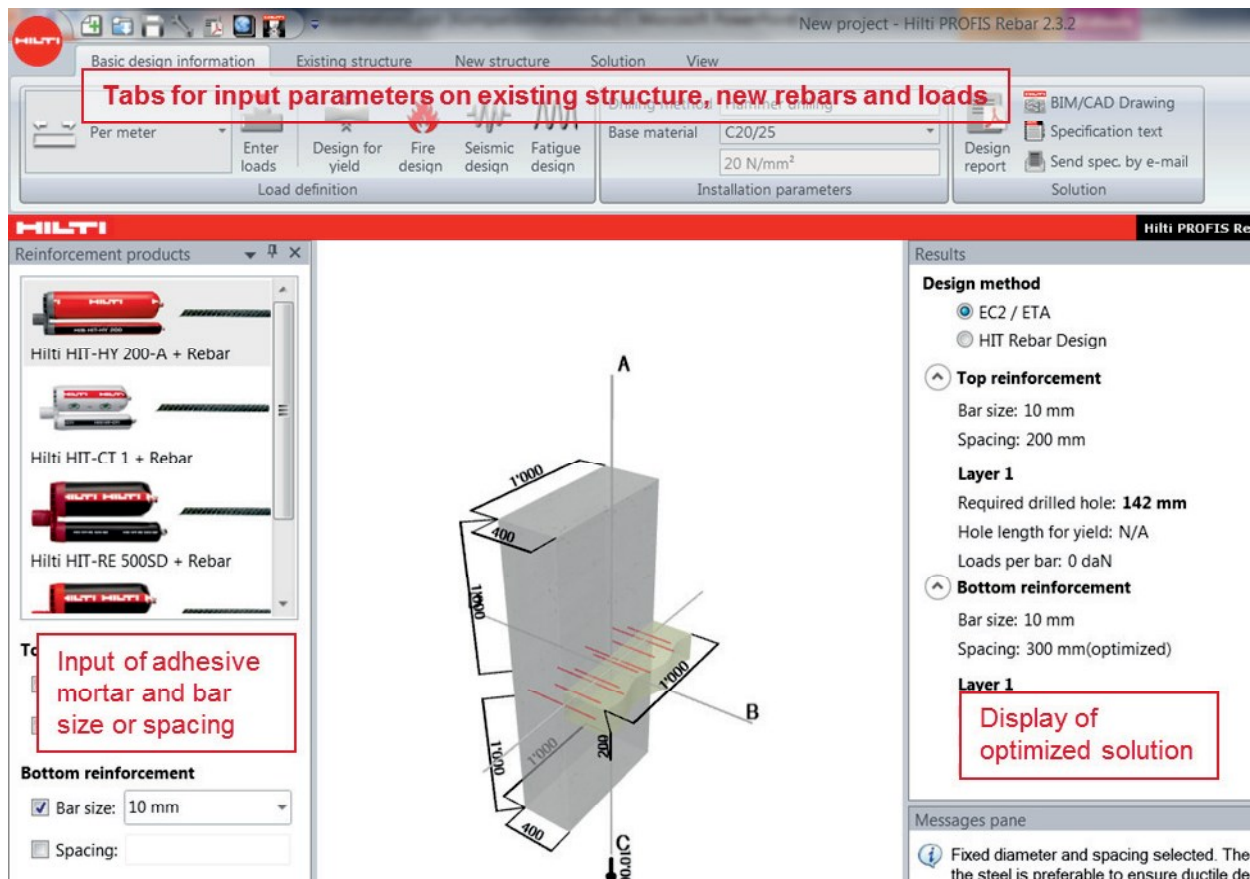



In the right hand ribbon the optimized solution, i.e. the one which uses the least possible cross section of connecting steel is indicated immediately.

Under the “calculation” tab, the user can get all possible solutions and select the appropriate one from a table.

Under the “solution tab” it is possible to print a design report, to download installation instructions or approvals, to access the Hilti online technical library or to send a specification by e-mail

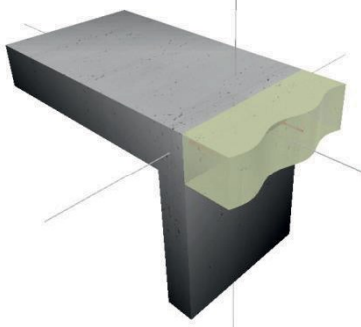
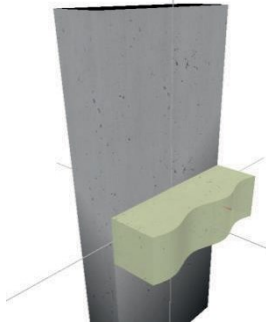
The applications are shown in the following table. For each case the table shows if there is a solution and if yes, which cast-in reinforcement must be defined in order to obtain a solution:

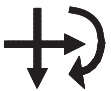
| | New and existing members parallel | New and existing members perpendicular | | |
|--|--|--|--|--|
| |  <p>design method:</p> |  <p>design method:</p> | | |
| Load | EC2 / ETA | Hit Rebar | EC2 / ETA | Hit Rebar |
| compression and/or shear  | With high compression requiring compressive reinforcement, existing reinforcement to be spliced is needed | | definition of cast-in reinforcement not required | |
| bending moment, shear and/or compression  | Overlap splice: Parallel cast-in reinforcement to be defined | | <i>No solution, concrete in tension</i> → PROFIS Anchor | Frame node: Perpendicular cast-in reinforcement to be defined |
| tension with or without bending moment and/or shear  | Overlap splice: Parallel cast-in reinforcement to be defined | | <i>No solution, concrete in tension</i> → PROFIS Anchor | |

Assumptions made by PROFIS Rebar in frame node design

Note that PROFIS Rebar is making simplified assumptions: it considers only the reactions to N_1 , V_1 , M_1 and it attributes them to the side of the base slab which is defined longer. If both sides of the base slab have the same length, the reaction is distributed to both sides equally:

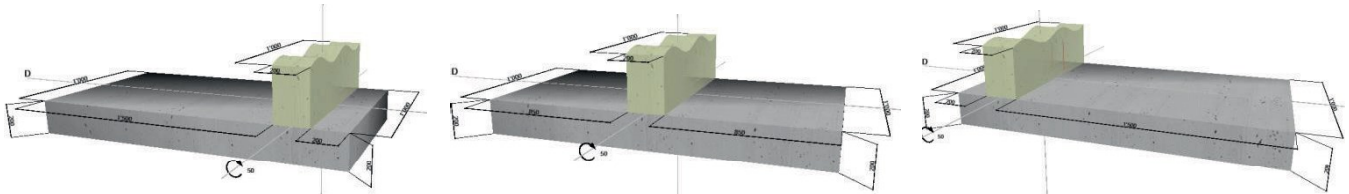

$$M_2 = -M_1 + V_1 \cdot \frac{z_2}{2} + N_1 \cdot \frac{z_1}{2}$$

$$M_3 = 0$$

$$V_2 = N_1; \quad V_3 = 0$$

$$N_2 = V_1; \quad N_3 = 0$$

$$M_2 = 0$$

$$M_3 = -M_1 + V_1 \cdot \frac{z_2}{2} + N_1 \cdot \frac{z_1}{2}$$

$$V_2 = 0; \quad V_3 = N_1$$

$$N_2 = 0; \quad N_3 = V_1$$

$$M_2 = 0.5 \cdot \left(-M_1 + V_1 \cdot \frac{z_2}{2} + N_1 \cdot \frac{z_1}{2} \right)$$

$$M_3 = 0.5 \cdot \left(-M_1 + V_1 \cdot \frac{z_2}{2} + N_1 \cdot \frac{z_1}{2} \right)$$

$$V_2 = V_3 = N_1 / 2;$$

$$N_2 = N_3 = V_1 / 2$$

Global equilibrium of the node as assumed in PROFIS Rebar

It is important to realize that the checks made by PROFIS Rebar are ONLY for the efforts introduced by the loading of the new concrete part. If the existing part is already loaded by other efforts, the total loading needs to be considered separately by the designer.

In analogy to the global equilibrium of the node, PROFIS Rebar makes the distinction between opening and closing moment on the basis of the length of the existing perpendicular parts on each side of the new part. The case where both perpendicular members have the same length is considered as opening moment since this yields results on the safe side.

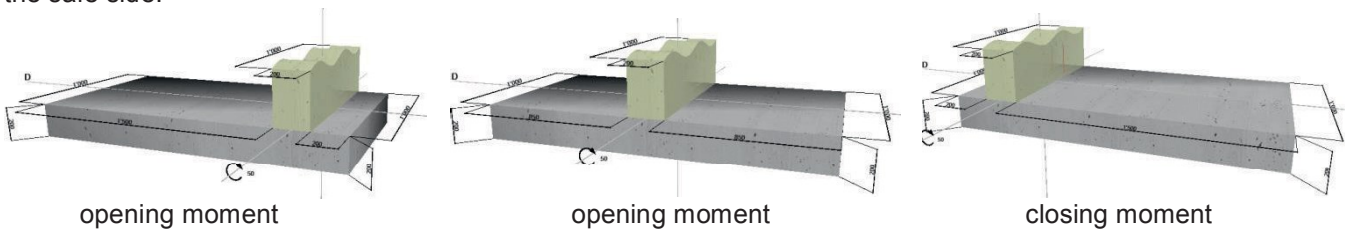
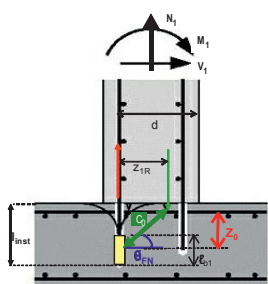

Figure 6: opening and closing moments assumed in PROFIS Rebar

Embedment depth:



- PROFIS Rebar will check the maximum possible setting depth according to ETAG 001, part 5: $h_{ef,max} = h_{member} - \max(2d_0; 30mm)$
- If $h_{ef,max}$ results in a strut angle $\theta_{FN} > 60^\circ$, the drill hole length will be selected such that $\theta_{FN} = 60^\circ$
- If $h_{ef,max}$ results in a strut angle $30^\circ \leq \theta_{FN} \leq 60^\circ$, the drill hole length will be $h_{ef,max}$
- If $h_{ef,max}$ results in a strut angle $\theta_{FN} < 30^\circ$, the strut angle is too small and the model provides no solution.

4 References

- [1] EN 1992-1-1:2011 Part 1-1: General rules and rules for buildings (Eurocode 2); January 2011
- [2] EOTA: Technical Report TR 023, Assessment of post- installed rebar connections, Edition Nov. 2006
- [3] EOTA: Technical Report TR 029, Design of Anchors, Edition Sept. 2010
- [4] EOTA: ETAG 001, part 5. bonded anchors. Brussels, 2008.
- [5] Kunz, J., Muenger F.: Splitting and Bond Failure of Post-Installed Rebar Splices and Anchorings. Bond in Concrete. fib, Budapest, 20 to 22 November 2002
- [6] Hamad, B.S., Al-Hammoud, R., Kunz, J.: Evaluation of Bond Strength of Bonded-In or Post-Installed Reinforcement. ACI Structural Journal, V. 103, No. 2, March – April 2006.
- [7] Kupfer, H., Münger, F., Kunz, J., Jähring, A.: Nachträglich verankerte gerade Bewehrungsstäbe bei Rahmenknoten. Bauingenieur: Sonderdruck, Springer Verlag,
- [8] HIT-Rebar – Design of bonded-in reinforcement using Hilti HIT-HY 150 or Hilti HIT-RE 500 for predominantly cyclic (fatigue) loading. Hilti Corporate Research, TWU-TPF-06a/02-d, Schaan 2002
- [9] Randl, N: Expertise zu Sonderfällen der Bemessung nachträglich eingemörtelter Bewehrungsstäbe; Teile A, B, C. University of Applied Science of Carinthia. Spittal (Austria), 2011.
- [10] CSTB: Document Technique d'Application 3/10-649 Relevant de l'Agrément Technique Europeen ATE 09/0295. Marne la Vallée (France), June 2010.

Eurocode 8: Auslegung von Bauwerken gegen Erdbeben – Teil 1: Grundlagen, Erdbebeneinwirkungen und Regeln für Hochbauten; Deutsche Fassung EN 1998-1:2004. April 2006

5 Installation of Post-Installed Reinforcement

5.1 Joint to be roughened

The model of inclined compressive struts is used to transfer the shear forces through the construction joint at the interface between concrete cast at different times. Therefore a rough interface is required to provide sufficient cohesion in the construction joint {Clause 6.2.5(2), EC2: EN 1992-1-1:2004}. Rough means a surface with at least 3 mm roughness ($R_t > 3 \text{ mm}$), achieved by raking, exposing the aggregate or other methods giving an equivalent behaviour.

5.2 Drilling

5.2.1 Standard Drilling

Injection anchor systems are used to fix reinforcement bars into concrete. Fast cure products are generally used with rebar diameters up to 25mm and moderate hole depths of up to about 1.5m, depending on the ambient temperature. Slow cure systems can be used with larger bar diameters and deep holes: The deepest rebar fixing to our knowledge so far was 12m. As rebar embedment lengths are usually much longer than with standard anchor applications, there are a number of additional system components helping to provide high quality of installation:

Drilling aid: Rebars are usually situated close to the concrete surface. If a long drill hole is not parallel to the surface, the inner lever arm of the structure will decrease along the hole if the deviation is away from the surface and even worse, the hole may penetrate the concrete surface or result in insufficient cover if the deviation is towards the surface. According to the rebar approvals, the deviations to be taken into account are 0.08 times the hole length (4.6°) for compressed air drilling, 0.06 times the hole length (3.4°) with hammer drilling and 0.02 times the hole length (1.1°) if a drilling aid is used (optical help or drilling rig, see fig. 11).



Figure 2.9: drilling aids

Depending on the required minimum concrete cover in every section of the post-installed rebar, the minimum “edge distance” at the start of the drilled hole is then:

$$c_{\min} = 50 + 0,08 l_v \geq 2\phi \text{ [mm]} \text{ for compressed air drilled holes}$$

$$c_{\min} = 30 + 0,06 l_v \geq 2\phi \text{ [mm]} \text{ for hammer drilled holes}$$

$$c_{\min} = 30 + 0,02 l_v \geq 2\phi \text{ [mm]} \text{ if a drilling aid is used}$$

5.3 Hole cleaning

The holes should be blown out using compressed, oil free air. Extension tubes and air nozzles directing the air to the hole walls should be used, if holes are deeper than 250mm.



Deeper holes than 250mm should as well be brushed by machine brushing using steel brushes and brush extensions:



Screw the round steel brush HIT-RB to the end of the brush extension(s) HIT-RBS, so that the overall length of the brush is sufficient to reach the base of the borehole. Attach the other end of the extension to the TE-C/TE-Y chuck.

The rebar approvals (ETA) give detailed information on the cleaning procedure for each product.

The following figure underlines the importance of adequate hole cleaning: For drilled holes cleaned according to the instruction, the post-installed bar (blue line) shows higher stiffness and higher resistance than the equivalent cast-in bar. With substandard cleaning (red line), however, stiffness and resistance are clearly below those of the cast-in bar.

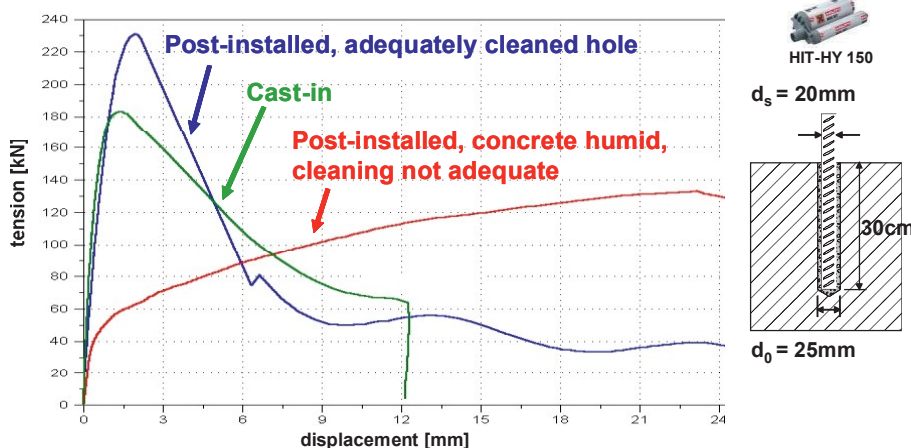

5.4 Injection and bar installation

It is important that air bubbles are avoided during the injection of the adhesive: when the bar is installed later, the air will be compressed and may eject part of the adhesive from the hole when the pressure exceeds the resistance of the liquid adhesive, thus endangering the installer. Moreover, the presence of air may prevent proper curing of the adhesive.

In order to reach the bottom of the drilled holes, mixer extensions shall be used. The holes should be filled with HIT to about 2/3. Marking the extension tubes at 1/3 of the hole length from the tip will help to dispense the correct amount of adhesive. Piston plugs ensure filling of the holes without air bubbles.

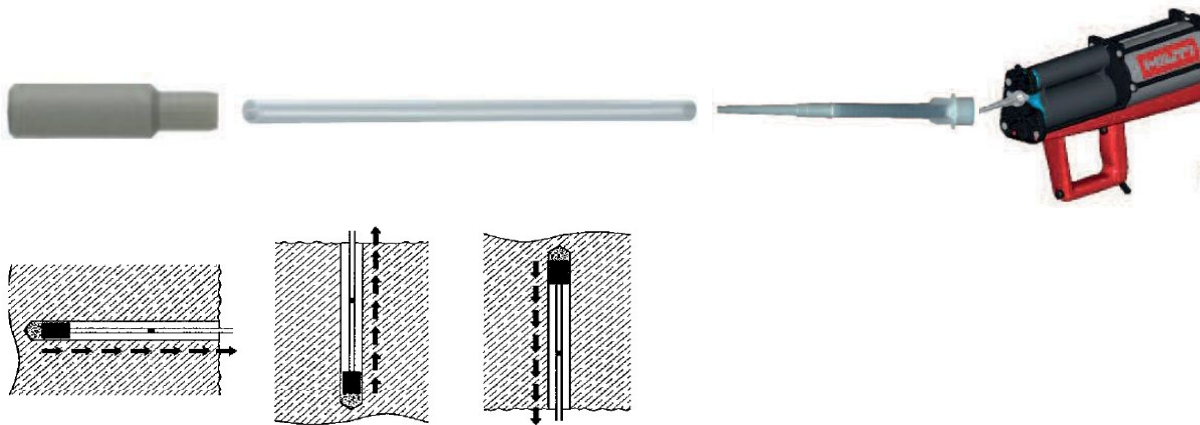

After injecting the HIT, the rebars should be inserted into the hole with a slight rotating movement. When rebars are installed overhead, dripping cups OHC can be used to prevent excess HIT from falling downward in an uncontrolled manner.



5.5 Installation instruction

For correct installation and the linked products, please refer to the detailed "Hilti HIT Installation guide for fastenings in concrete", Hilti Corp., Schaan W3362 1007 as well as to the product specific rebar approvals.

5.6 Mortar consumption estimation for post-installed rebars

Hilti supplies a perfectly matched, quick and easy system for making reliable post-installed rebar connections. When embedment depth and rebar diameter are known, just calculate the number of Hilti HIT cartridges needed.

In the following table please find the quantity of mortar required for one fastening point, in ml. In this estimation, we consider 80% of the mortar is used for fastening, the rest being used for the first pull outs and waste.

The greyed area should not be used since it is not in accordance with the design codes requiring a depth of at least 10 drilling diameters.

Mortar consumption estimation for post-installed rebars (in ml)

| Rebar \varnothing d_s [mm] | 8 | 10 | 12 | 14 | 16 | 18 | 20 | 22 | 24 |
|---------------------------------------|-------|-------|-------|-------|-------|-------|-------|-------|--------|
| Drill bit \varnothing d_0 [mm] | 12 | 14 | 16 | 18 | 20 | 22 | 25 | 28 | 32 |
| Hole depth [mm] | | | | | | | | | |
| 100 | 8,0 | 9,6 | 11,2 | 12,8 | 14,3 | 15,9 | 22,2 | 29,3 | 43,4 |
| 120 | 9,6 | 11,5 | 13,4 | 15,3 | 17,2 | 19,1 | 26,6 | 35,2 | 52,1 |
| 140 | 11,2 | 13,4 | 15,6 | 17,8 | 20,1 | 22,3 | 31,0 | 41,1 | 60,8 |
| 160 | 12,8 | 15,3 | 17,9 | 20,4 | 22,9 | 25,5 | 35,4 | 46,9 | 69,5 |
| 180 | 14,4 | 17,2 | 20,1 | 22,9 | 25,8 | 28,6 | 39,9 | 52,8 | 78,2 |
| 200 | 16,0 | 19,2 | 22,3 | 25,5 | 28,7 | 31,8 | 44,3 | 58,7 | 86,9 |
| 240 | 19,2 | 23,0 | 26,8 | 30,6 | 34,4 | 38,2 | 53,2 | 70,4 | 104,2 |
| 260 | 20,8 | 24,9 | 29,0 | 33,1 | 37,3 | 41,4 | 57,6 | 76,3 | 112,9 |
| 280 | 22,4 | 26,8 | 31,3 | 35,7 | 40,1 | 44,6 | 62,0 | 82,1 | 121,6 |
| 300 | 24,0 | 28,7 | 33,5 | 38,2 | 43,0 | 47,7 | 66,5 | 88,0 | 130,3 |
| 320 | 25,6 | 30,7 | 35,7 | 40,8 | 45,9 | 50,9 | 70,9 | 93,9 | 139,0 |
| 340 | 27,2 | 32,6 | 38,0 | 43,3 | 48,7 | 54,1 | 75,3 | 99,7 | 147,7 |
| 360 | 28,8 | 34,5 | 40,2 | 45,9 | 51,6 | 57,3 | 79,8 | 105,6 | 156,4 |
| 380 | 30,4 | 36,4 | 42,4 | 48,4 | 54,5 | 60,5 | 84,2 | 111,5 | 165,1 |
| 400 | 32,0 | 38,3 | 44,7 | 51,0 | 57,3 | 63,7 | 88,6 | 117,3 | 173,7 |
| 450 | 36,0 | 43,1 | 50,2 | 57,4 | 64,5 | 71,6 | 99,7 | 132,0 | 195,5 |
| 500 | 40,0 | 47,9 | 55,8 | 63,7 | 71,7 | 79,6 | 110,8 | 146,7 | 217,2 |
| 550 | 44,0 | 52,7 | 61,4 | 70,1 | 78,8 | 87,5 | 121,8 | 161,3 | 238,9 |
| 600 | 48,0 | 57,5 | 67,0 | 76,5 | 86,0 | 95,5 | 132,9 | 176,0 | 260,6 |
| 650 | 52,0 | 62,3 | 72,6 | 82,9 | 93,1 | 103,4 | 144,0 | 190,7 | 282,3 |
| 700 | 56,0 | 67,1 | 78,1 | 89,2 | 100,3 | 111,4 | 155,1 | 205,3 | 304,0 |
| 750 | 60,0 | 71,9 | 83,7 | 95,6 | 107,5 | 119,4 | 166,1 | 220,0 | 325,8 |
| 800 | 64,0 | 76,6 | 89,3 | 102,0 | 114,6 | 127,3 | 177,2 | 234,7 | 347,5 |
| 850 | 68,0 | 81,4 | 94,9 | 108,3 | 121,8 | 135,3 | 188,3 | 249,3 | 369,2 |
| 900 | 72,0 | 86,2 | 100,5 | 114,7 | 129,0 | 143,2 | 199,4 | 264,0 | 390,9 |
| 950 | 76,0 | 91,0 | 106,1 | 121,1 | 136,1 | 151,2 | 210,4 | 278,7 | 412,6 |
| 1000 | 80,0 | 95,8 | 111,6 | 127,5 | 143,3 | 159,1 | 221,5 | 293,3 | 434,3 |
| 1200 | 96,0 | 115,0 | 134,0 | 153,0 | 172,0 | 191,0 | 265,8 | 352,0 | 521,2 |
| 1400 | 111,9 | 134,1 | 156,3 | 178,4 | 200,6 | 222,8 | 310,1 | 410,7 | 608,1 |
| 1600 | 127,9 | 153,3 | 178,6 | 203,9 | 229,3 | 254,6 | 354,4 | 469,3 | 694,9 |
| 1800 | 143,9 | 172,4 | 200,9 | 229,4 | 257,9 | 286,4 | 398,7 | 528,0 | 781,8 |
| 2000 | 159,9 | 191,6 | 223,3 | 254,9 | 286,6 | 318,3 | 443,0 | 586,7 | 868,7 |
| 2500 | 199,9 | 239,5 | 279,1 | 318,7 | 358,2 | 397,8 | 553,8 | 733,3 | 1085,8 |
| 3000 | 239,9 | 287,4 | 334,9 | 382,4 | 429,9 | 477,4 | 664,6 | 880,0 | 1303,0 |
| 3200 | 255,9 | 306,5 | 357,2 | 407,9 | 458,5 | 509,2 | 708,9 | 938,7 | 1389,9 |

| 25 | 26 | 28 | 30 | 32 | 34 | 36 | 40 | Rebar Ø d _s [mm] |
|--------|--------|--------|--------|--------|--------|--------|--------|------------------------------------|
| 32 | 35 | 35 | 37 | 40 | 45 | 45 | 55 | Drill bit Ø d ₀ [mm] |
| | | | | | | | | Hole depth [mm] |
| 38,8 | 53,1 | 42,9 | 45,6 | 55,8 | 83,6 | 70,4 | 136,4 | 100 |
| 46,6 | 63,7 | 51,5 | 54,7 | 67,0 | 100,3 | 84,5 | 163,7 | 120 |
| 54,3 | 74,3 | 60,0 | 63,8 | 78,1 | 117,0 | 98,6 | 190,9 | 140 |
| 62,1 | 84,9 | 68,6 | 73,0 | 89,3 | 133,8 | 112,7 | 218,2 | 160 |
| 69,9 | 95,5 | 77,2 | 82,1 | 100,4 | 150,5 | 126,7 | 245,5 | 180 |
| 77,6 | 106,1 | 85,8 | 91,2 | 111,6 | 167,2 | 140,8 | 272,8 | 200 |
| 93,2 | 127,4 | 102,9 | 109,4 | 133,9 | 200,6 | 169,0 | 327,3 | 240 |
| 100,9 | 138,0 | 111,5 | 118,6 | 145,1 | 217,4 | 183,1 | 354,6 | 260 |
| 108,7 | 148,6 | 120,1 | 127,7 | 156,2 | 234,1 | 197,1 | 381,9 | 280 |
| 116,5 | 159,2 | 128,7 | 136,8 | 167,4 | 250,8 | 211,2 | 409,1 | 300 |
| 124,2 | 169,8 | 137,2 | 145,9 | 178,6 | 267,5 | 225,3 | 436,4 | 320 |
| 132,0 | 180,4 | 145,8 | 155,0 | 189,7 | 284,3 | 239,4 | 463,7 | 340 |
| 139,7 | 191,0 | 154,4 | 164,2 | 200,9 | 301,0 | 253,5 | 491,0 | 360 |
| 147,5 | 201,7 | 163,0 | 173,3 | 212,0 | 317,7 | 267,6 | 518,3 | 380 |
| 155,3 | 212,3 | 171,6 | 182,4 | 223,2 | 334,4 | 281,6 | 545,5 | 400 |
| 174,7 | 238,8 | 193,0 | 205,2 | 251,1 | 376,2 | 316,8 | 613,7 | 450 |
| 194,1 | 265,3 | 214,4 | 228,0 | 279,0 | 418,0 | 352,0 | 681,9 | 500 |
| 213,5 | 291,9 | 235,9 | 250,8 | 306,9 | 459,8 | 387,2 | 750,1 | 550 |
| 232,9 | 318,4 | 257,3 | 273,6 | 334,8 | 501,6 | 422,4 | 818,3 | 600 |
| 252,3 | 344,9 | 278,8 | 296,4 | 362,7 | 543,4 | 457,6 | 886,5 | 650 |
| 271,7 | 371,5 | 300,2 | 319,2 | 390,6 | 585,2 | 492,9 | 954,7 | 700 |
| 291,1 | 398,0 | 321,7 | 342,0 | 418,5 | 627,0 | 528,1 | 1022,9 | 750 |
| 310,5 | 424,5 | 343,1 | 364,8 | 446,4 | 668,8 | 563,3 | 1091,0 | 800 |
| 329,9 | 451,1 | 364,5 | 387,6 | 474,3 | 710,6 | 598,5 | 1159,2 | 850 |
| 349,3 | 477,6 | 386,0 | 410,4 | 502,2 | 752,4 | 633,7 | 1227,4 | 900 |
| 368,7 | 504,1 | 407,4 | 433,2 | 530,1 | 794,2 | 668,9 | 1295,6 | 950 |
| 388,2 | 530,7 | 428,9 | 456,0 | 558,0 | 836,0 | 704,1 | 1363,8 | 1000 |
| 465,8 | 636,8 | 514,6 | 547,2 | 669,6 | 1003,2 | 844,9 | 1636,6 | 1200 |
| 543,4 | 742,9 | 600,4 | 638,4 | 781,2 | 1170,4 | 985,7 | 1909,3 | 1400 |
| 621,0 | 849,0 | 686,2 | 729,6 | 892,8 | 1337,6 | 1126,5 | 2182,1 | 1600 |
| 698,7 | 955,2 | 772,0 | 820,8 | 1004,4 | 1504,8 | 1267,3 | 2454,9 | 1800 |
| 776,3 | 1061,3 | 857,7 | 912,0 | 1116,0 | 1672,0 | 1408,1 | 2727,6 | 2000 |
| 970,4 | 1326,6 | 1072,2 | 1140,0 | 1395,0 | 2090,0 | 1760,2 | 3409,5 | 2500 |
| 1164,5 | 1592,0 | 1286,6 | 1368,0 | 1674,0 | 2508,1 | 2112,2 | 4091,4 | 3000 |
| 1242,1 | 1698,1 | 1372,4 | 1459,2 | 1785,6 | 2675,3 | 2253,0 | 4364,2 | 3200 |

Hilti HIT-RE 500-SD mortar with rebar (as post-installed connection)

| Injection mortar system | Benefits |
|---|--|
|  <p data-bbox="810 524 1002 752">Hilti HIT-RE 500-SD 330 ml foil pack (also available as 500 ml and 1400 ml foil pack)</p> <p data-bbox="810 853 954 880">Statik mixer</p> <p data-bbox="810 972 884 999">Rebar</p> | <ul style="list-style-type: none"> - SAFEset technology: drilling and borehole cleaning in one step with Hilti hollow drill bit - suitable for concrete C 12/15 to C 50/60 - high loading capacity - suitable for dry and water saturated concrete - for rebar diameters up to 40 mm - non corrosive to rebar elements - long working time at elevated temperatures - odourless epoxy - suitable for embedment length till 3200 mm |

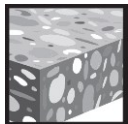

Concrete



Fire
resistance



Diamond
drilled
holes



European
Technical
Approval



Corossion
tested



PROFIS
Rebar design
software



Hilti **SAFEset**
technology with
hollow drill bit

Service temperature range

Temperature range: -40°C to +80°C (max. long term temperature +50°C, max. short term temperature +80°C).

Approvals / certificates

| Description | Authority / Laboratory | No. / date of issue |
|-----------------------------|------------------------|----------------------------|
| European technical approval | DIBt, Berlin | ETA-09/0295 / 2013-05-09 |
| Application document | CSTB, Marne la Vallée | DTA-3/10-649 / 2010-06-17 |
| European technical approval | DIBt, Berlin | ETA-07/0260 / 2013-06-26 |
| Assessment | MFPA Leipzig GmbH | GS 3.2/09-122 / 2010-05-26 |

^{a)} All data given in this section according to the approvals mentioned above, ETA-09/0295 issue 2013-05-09 and ETA-07/0260 issue 2013-06-26.

Materials

Reinforcement bars according to EC2 Annex C Table C.1 and C.2N.

Properties of reinforcement

| Product form | | Bars and de-coiled rods | |
|---|-----------------------|-------------------------|-----------------------|
| Class | | B | C |
| Characteristic yield strength f_{yk} or $f_{0,2k}$ (MPa) | | 400 to 600 | |
| Minimum value of $k = (f_t/f_y)_k$ | | $\geq 1,08$ | $\geq 1,15$ < 1,35 |
| Characteristic strain at maximum force, ϵ_{uk} (%) | | $\geq 5,0$ | $\geq 7,5$ |
| Bendability | | Bend / Rebend test | |
| Maximum deviation from nominal mass (individual bar) (%) | Nominal bar size (mm) | | |
| | ≤ 8 | $\pm 6,0$ | |
| | > 8 | $\pm 4,5$ | |
| Bond: Minimum relative rib area, $f_{R,min}$ | Nominal bar size (mm) | | |
| | 8 to 12 | 0,040 | |
| | > 12 | 0,056 | |

Setting details

For detailed information on installation see instruction for use given with the package of the product.

Curing time for general conditions



| Data according ETA-09/0295, issue 2013-05-09 | | | |
|--|--|------------------------------------|---|
| Temperature of the base material | Working time in which rebar can be inserted and adjusted t_{gel} | Initial curing time $t_{cure,ini}$ | Curing time before rebar can be fully loaded t_{cure} |
| $5\text{ °C} \leq T_{BM} < 10\text{ °C}$ | 2 h | 18 h | 72 h |
| $10\text{ °C} \leq T_{BM} < 15\text{ °C}$ | 90 min | 12 h | 48 h |
| $15\text{ °C} \leq T_{BM} < 20\text{ °C}$ | 30 min | 9 h | 24 h |
| $20\text{ °C} \leq T_{BM} < 25\text{ °C}$ | 20 min | 6 h | 12 h |
| $25\text{ °C} \leq T_{BM} < 30\text{ °C}$ | 20 min | 5 h | 12 h |
| $30\text{ °C} \leq T_{BM} < 40\text{ °C}$ | 12 min | 4 h | 8 h |
| $T_{BM} = 40\text{ °C}$ | 12 min | 4 h | 4 h |

For dry concrete curing times may be reduced according to the following table. For installation temperatures below +5 °C all load values have to be reduced according to the load reduction factors given below.

Curing time for dry concrete

| Additional Hilti technical data | | | | |
|----------------------------------|--|------------------------------------|---|-----------------------|
| Temperature of the base material | Working time in which rebar can be inserted and adjusted t_{gel} | Initial curing time $t_{cure,ini}$ | Reduced curing time before rebar can be fully loaded t_{cure} | Load reduction factor |
| $T_{BM} = -5\text{ °C}$ | 4 h | 36 h | 72 h | 0,6 |
| $T_{BM} = 0\text{ °C}$ | 3 h | 25 h | 50 h | 0,7 |
| $T_{BM} = 5\text{ °C}$ | 2 ½ h | 18 h | 36 h | 1 |
| $T_{BM} = 10\text{ °C}$ | 2 h | 12 h | 24 h | 1 |
| $T_{BM} = 15\text{ °C}$ | 1 ½ h | 9 h | 18 h | 1 |
| $T_{BM} = 20\text{ °C}$ | 30 min | 6 h | 12 h | 1 |
| $T_{BM} = 30\text{ °C}$ | 20 min | 4 h | 8 h | 1 |
| $T_{BM} = 40\text{ °C}$ | 12 min | 2 h | 4 h | 1 |

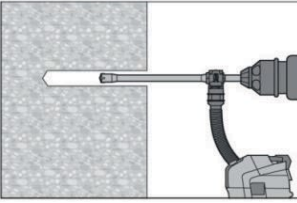
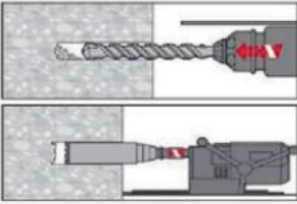
Setting instruction

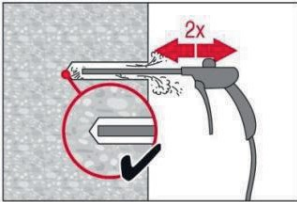
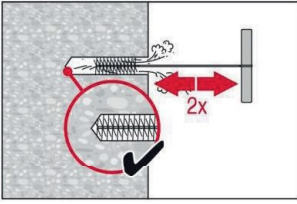
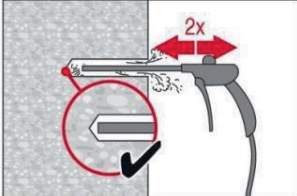
| | |
|---|---|
| <p>Safety Regulations:</p>  | <p>Review the Material Safety Data Sheet (MSDS) before use for proper and safe handling! Wear well-fitting protective goggles and protective gloves when working with Hilti HIT-RE 500-SD. Important: Observe the installation instruction of the manufacturer provided with each foil pack.</p> |
| <p>1. Drill hole</p> | <p>Note: Before drilling, remove carbonized concrete; clean contact areas (see Annex B1) In case of aborted drill hole the drill hole shall be filled with mortar.</p> |
|  | <p>Drill hole to the required embedment depth with an appropriately sized Hilti TE-CD or TE-YD hollow drill bit with Hilti vacuum attachment. This drilling system removes the dust and cleans the bore hole during drilling when used in accordance with the user's manual. After drilling is complete, proceed to the "injection preparation" step in the instructions for use.</p> |
|  | <p>Drill the hole to the required embedment depth using a hammer-drill with carbid drill bit set in rotation hammer mode, a compressed air drill or a diamond core machine.</p> <p>Hammer drill (HD) Compressed air drill (CA) Diamond core wet (DD) and dry (PCC)</p>  |
| <p>3. Bore hole cleaning</p> | <p>(Not needed with Hilti TE-CD and Hilti TE-YD drill bit) The borehole must be free of dust, debris, water, ice, oil, grease and other contaminants prior to mortar injection.</p> <p>Just before setting an anchor, the bore hole must be free of dust and debris by one of two cleaning methods described below</p> |
| <p>Compressed air cleaning (CAC)</p> | |
|  | <p>Blowing 2 times from the back of the hole with oil-free compressed air (min. 6 bar at 100 litres per minute (LPM)) until return air stream is free of noticeable dust. Bore hole diameter ≥ 32 mm the compressor must supply a minimum air flow of 140 m³/hour. If required use additional accessories and extensions for air nozzle and brush to reach back of hole.</p> |
|  | <p>Brushing 2 times with the specified brush HIT-RB size (brush $\varnothing \geq$ borehole \varnothing) by inserting the round steel brush to the back of the hole in a twisting motion. The brush shall produce natural resistance as it enters the anchor hole. If this is not the case, please use a new brush or a brush with a larger diameter.</p> |
|  | <p>Blowing 2 times again with compressed air until return air stream is free of noticeable dust. If required use additional accessories and extensions for air nozzle and brush to reach back of hole.</p> |

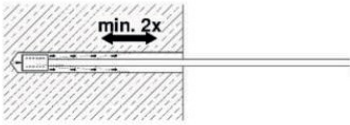

Deep boreholes – Blowing

For boreholes deeper than 250mm (for $\varnothing=8\text{mm} - 12\text{mm}$) or deeper than $20 \varnothing$ (for $\varnothing>12\text{mm}$) use the appropriate air nozzle Hilti HIT-DL

Safety tip: Do not inhale concrete dust.

The application of the dust collector Hilti HIT-DRS is recommended.

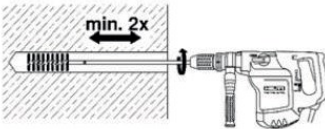

Deep boreholes – Brushing

For boreholes deeper than 250 mm (for $\varnothing=8\text{mm} - 12\text{mm}$) or deeper than $20 \varnothing$ (for $\varnothing>12\text{mm}$) use machine brushing and brush extensions HIT-RBS.

Screw the round steel brush HIT-RB in one end of the brush extension(s) HIT-RBS, so that the overall length of the brush is sufficient to reach the base of the borehole. Attach the other end of the extension to the TE-C/TE-Y chuck.

Safety tip:

- Start machine brushing operational slowly.
- Start brushing operation once brush is inserted in borehole.

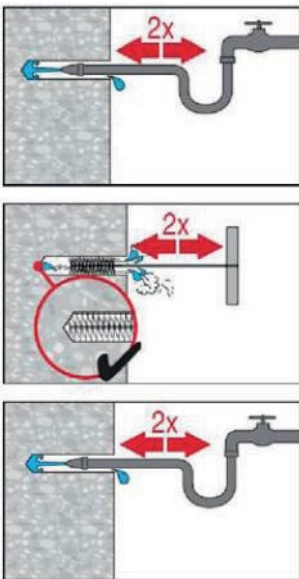

In addition for wet diamond coring (DD):

For wet diamond coring please observe the following steps in addition **prior to** compressed air cleaning:

Remove all core fragments from the anchor hole. Flush the anchor hole with clear running water until water runs clear. Brush the anchor hole again 2 times with the appropriate sized brush over the entire depth of the anchor hole. Repeat the flushing process until water runs out of the anchor hole.

Manual Cleaning (MC) Manual cleaning is permitted for hammer drilled boreholes up to hole diameters $d_0 \leq 20\text{mm}$ and depths l_v resp. $l_{e,ges.} \leq 160\text{mm}$.

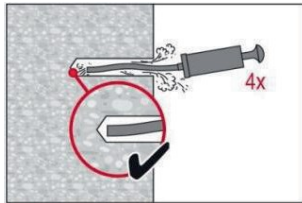

Blowing
4 strokes with Hilti blow-out pump from the back of the hole until return air stream is free of noticeable dust.

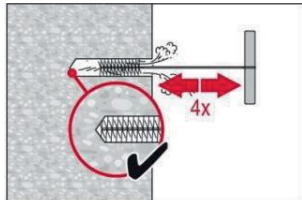

Brushing
4 times with the specified brush HIT_RB size (brush $\varnothing \geq$ borehole \varnothing) by inserting the round steel wire brush to the back of the hole with a twisting motion. The brush shall produce natural resistance as it enters the anchor hole. If this is not the case, please use a new brush or a brush with a larger diameter.

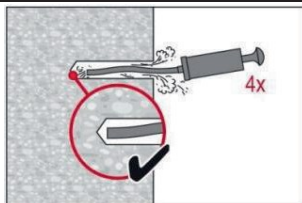

Blowing
4 strokes with Hilti blow-out pump from the back of the hole until return air stream is free of noticeable dust.



Manual Cleaning (MC)

Hilti hand pump recommended for blowing out bore hole with diameters $d < 20\text{mm}$ and bore hole depth $h_0 < 160\text{mm}$

3.Rebar preparation and foil pack preparation

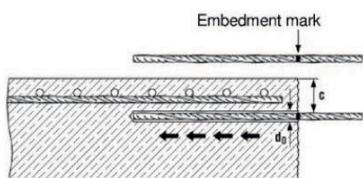

Before use, make sure the rebar is dry and free of oil or other residue.

Mark the embedment depth on the rebar. (e.g. with tape), l_v

Insert rebar in borehole, to verify hole and setting depth l_v resp. $l_{e,ges}$

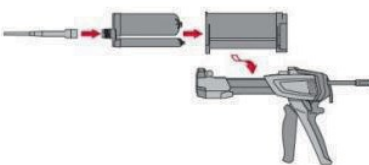

- Observe the Instruction for Use of the dispenser and the mortar.
- Tightly attach Hilti HIT-RE-M mixing nozzle to foil pack manifold.
- Insert foil pack into foil pack holder and swing holder into the dispenser.

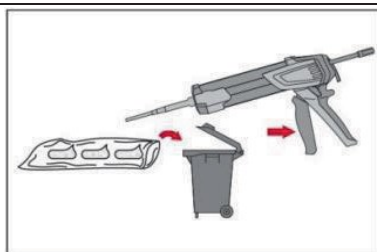

Discard initial mortar. The foil pack opens automatically as dispensing is initiated. Depending on the size of the foil pack an initial amount of adhesive has to be discarded. After changing a mixing nozzle, the first few trigger pulls must be discarded as described above. For each new foil pack a new mixing nozzle must be used.

Discard quantities are

- 3 strokes for 330 ml foil pack,
- 4 strokes for 500 ml foil pack,
- 65 ml for 1400 ml foil pack,

4.Inject mortar into borehole Forming air pockets be avoided

4.1 Injection method for borehole depth ≤ 250 mm

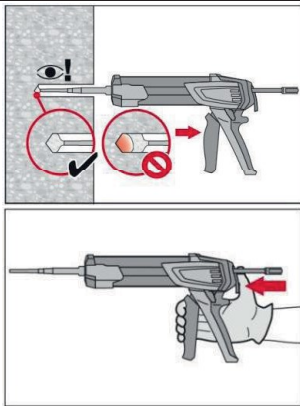

Inject the mortar from the back of the hole towards the front and slowly withdraw the mixing nozzle step by step after each trigger pull.
Fill holes approximately 2/3 full, or as required to ensure that the annular gap between the rebar and the concrete is completely filled with adhesive over the embedment length.
After injecting, depressurize the dispenser by pressing the release trigger. This will prevent further mortar discharge from the mixing nozzle.

4.2 Injection method for borehole depth > 250 mm or overhead application

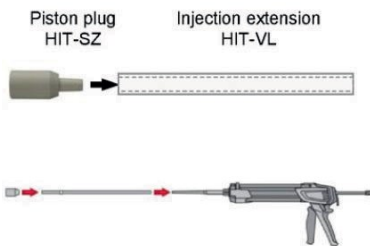

Assemble mixing nozzle HIT-RE-M, extension(s) and piston plug HIT-SZ.
For combinations of several injection extensions use coupler HIT-VL K. A substitution of the injection extension for a plastic hose or a combination of both is permitted.
The combination of HIT-SZ piston plug with HIT-VL 16 pipe and then HIT-VL 16 tube support proper injection.

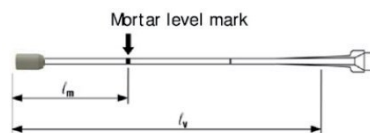

Mark the required mortar level ℓ_m and embedment depth ℓ_b resp. $\ell_{e,ges}$ with tape or marker on the injection extension.

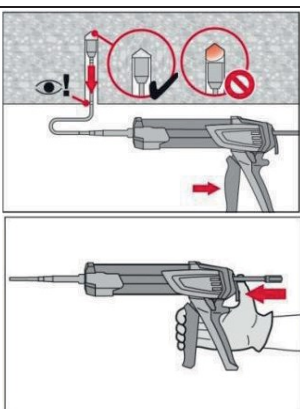

Insert piston plug to back of the hole. Begin injection allowing the pressure of the injected adhesive mortar to push the piston plug towards the front of the hole.
Fill holes approximately 2/3 full, or as required to ensure that the annular gap between the rebar and the concrete is completely filled with adhesive over the embedment length.
Injection until the mortar level mark ℓ_m becomes visible.
After injecting, depressurize the dispenser by pressing the release trigger. This will prevent further mortar discharge from the mixing nozzle.

5. Insert rebar

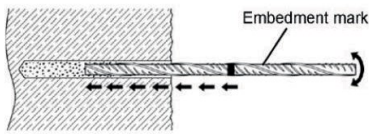

For easy installation insert the rebar slowly twisted into the borehole until the embedment mark is at the concrete surface level.

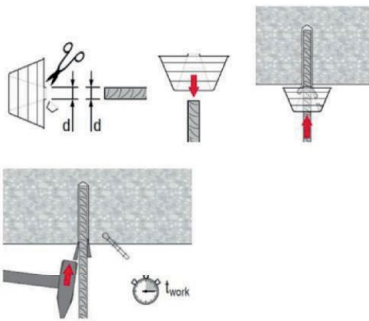

Overhead application:

During insertion of the rebar, mortar might flow out of the borehole. For collection of the flowing mortar, HIT-OHC may be used.

Support the rebar and secure it from falling till mortar started to harden, e.g. using wedges HIT-OHW.

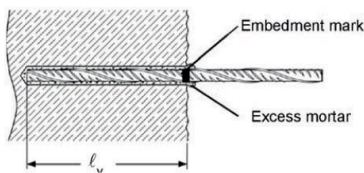

After installing the rebar the annular gap must be completely filled with mortar.

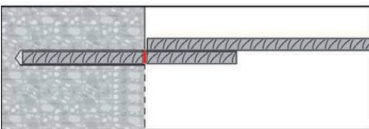

After installing the rebar the annular gap must be completely filled with mortar.

Proper installation can be verified when:

Desired anchoring embedment is reached l_v : embedment mark at concrete surface.

Excess mortar flows out of the borehole after the rebar has been fully inserted until the embedment mark.

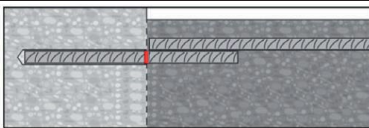

Full load may be applied only after the curing time " t_{cure} " has elapsed.

Fitness for use

Some creep tests have been conducted in accordance with ETAG guideline 001 part 5 and TR 023 in the following conditions : in dry environment at 50 °C during 90 days.

These tests show an excellent behaviour of the post-installed connection made with HIT-RE 500-SD: low displacements with long term stability, failure load after exposure above reference load.

Resistance to chemical substances

| Categories | Chemical substances | Resistant | Non resistant |
|------------------------|--|-----------|---------------|
| Alkaline products | Drilling dust slurry pH = 12,6 | + | |
| | Potassium hydroxide solution (10%) pH = 14 | + | |
| Acids | Acetic acid (10%) | | + |
| | Nitric acid (10%) | | + |
| | Hydrochloric acid (10%) | | + |
| | Sulfuric acid (10%) | | + |
| Solvents | Benzyl alcohol | | + |
| | Ethanol | | + |
| | Ethyl acetate | | + |
| | Methyl ethyl keton (MEK) | | + |
| | Trichlor ethylene | | + |
| | Xylol (mixture) | + | |
| Products from job site | Concrete plasticizer | + | |
| | Diesel | + | |
| | Engine oil | + | |
| | Petrol | + | |
| | Oil for form work | + | |
| Environnement | Sslt water | + | |
| | De-mineralised water | + | |
| | Sulphurous atmosphere (80 cycles) | + | |

Electrical Conductivity

HIT-RE 500-SD in the hardened state **is not conductive electrically**. Its electric resistivity is $66 \cdot 10^{12} \Omega \cdot m$ (DIN IEC 93 – 12.93). It is adapted well to realize electrically insulating anchorings (ex: railway applications, subway).

Drilling diameters

| Rebar (mm) | Drill bit diameters d_0 [mm] | | | |
|------------|---|------------------------------|------------------------|-----------|
| | Hammer drill (HD) Hollow Drill Bit (HDB) | Compressed air drill (CA) | Diamond coring | |
| | | | Wet (DD) | Dry (PCC) |
| 8 | 12 (10 ^{a)}) | - | 12 (10 ^{a)}) | - |
| 10 | 14 (12 ^{a)}) | - | 14 (12 ^{a)}) | - |
| 12 | 16 (14 ^{a)}) | 17 | 16 (14 ^{a)}) | - |
| 14 | 18 | 17 | 18 | - |
| 16 | 20 | 20 | 20 | - |
| 18 | 22 | 22 | 22 | - |
| 20 | 25 | 26 | 25 | - |
| 22 | 28 | 28 | 28 | - |
| 24 | 32 | 32 | 32 | 35 |
| 25 | 32 | 32 | 32 | 35 |
| 26 | 35 | 35 | 35 | 35 |
| 28 | 35 | 35 | 35 | 35 |
| 30 | 37 | 35 | 37 | 35 |
| 32 | 40 | 40 | 40 | 47 |
| 34 | 45 | 42 | 42 | 47 |
| 36 | 45 | 45 | 47 | 47 |
| 40 | 55 | 57 | 52 | 52 |

a) Max. installation length $l = 250$ mm.

Basic design data for rebar design according to rebar ETA

Bond strength in N/mm² according to ETA 09/0295 for good bond conditions for hammer drilling, compressed air drilling, dry diamond core drilling

| Rebar (mm) | Concrete class | | | | | | | | |
|---------------|----------------|--------|--------|--------|--------|--------|--------|--------|--------|
| | C12/15 | C16/20 | C20/25 | C25/30 | C30/37 | C35/45 | C40/50 | C45/55 | C50/60 |
| 8 - 32 | 1,6 | 2,0 | 2,3 | 2,7 | 3,0 | 3,4 | 3,7 | 4,0 | 4,3 |
| 34 | 1,6 | 2,0 | 2,3 | 2,6 | 2,9 | 3,3 | 3,6 | 3,9 | 4,2 |
| 36 | 1,5 | 1,9 | 2,2 | 2,6 | 2,9 | 3,3 | 3,6 | 3,8 | 4,1 |
| 40 | 1,5 | 1,8 | 2,1 | 2,5 | 2,8 | 3,1 | 3,4 | 3,7 | 4,0 |

Bond strength in N/mm² according to ETA 09/0295 for good bond conditions for wet diamond core drilling

| Rebar (mm) | Concrete class | | | | | | | | |
|----------------|----------------|--------|--------|--------|--------|--------|--------|--------|--------|
| | C12/15 | C16/20 | C20/25 | C25/30 | C30/37 | C35/45 | C40/50 | C45/55 | C50/60 |
| 8 - 25 | 1,6 | 2,0 | 2,3 | 2,7 | 3,0 | 3,4 | 3,7 | 4,0 | 4,3 |
| 26 - 32 | 1,6 | 2,0 | 2,3 | 2,7 | 2,7 | 2,7 | 2,7 | 2,7 | 2,7 |
| 34 | 1,6 | 2,0 | 2,3 | 2,6 | 2,6 | 2,6 | 2,6 | 2,6 | 2,6 |
| 36 | 1,5 | 1,9 | 2,2 | 2,6 | 2,6 | 2,6 | 2,6 | 2,6 | 2,6 |
| 40 | 1,5 | 1,8 | 2,1 | 2,5 | 2,5 | 2,5 | 2,5 | 2,5 | 2,5 |

Pullout design bond strength for Hit Rebar design

Design bond strength in N/mm² according to ETA 07/0260 (values in table are design values, $f_{bd,po} = \tau_{Rk}/\gamma_{Mp}$)

Hammer or compressed air drilling.
Water saturated, water filled or submerged hole.
Uncracked concrete C20/25.

| temperature range | Bar diameter | | | | | | | | | | | | | | | |
|-------------------|-------------------------------|----|----|-----|-----|-----|-----|----|-----|----|-----|----|-----------------|-----|-----|--|
| | Data according to ETA 04/0027 | | | | | | | | | | | | Hilti tech data | | | |
| | 8 | 10 | 12 | 14 | 16 | 20 | 22 | 24 | 25 | 26 | 28 | 30 | 32 | 36 | 40 | |
| I: 40°C/24°C | 7,1 | | | 6,7 | | | 6,2 | | | | | | 5,2 | 4,8 | | |
| II: 58°C/35°C | 5,7 | | | | 5,2 | | | | 4,8 | | | | 4,3 | 3,8 | | |
| III: 70°C/43°C | 3,3 | | | | | 3,1 | | | | | 2,9 | | | | 2,4 | |

Increasing factor in non-cracked concrete: $f_{B,p} = (f_{cck}/25)^{0,1}$ (f_{cck} : characteristic compressive strength on cube)

Additional Hilti Technical Data:

If the concrete is dry (not in contact with water before/during installation and curing), the pullout design bond strength may be increased by 20%.

If the hole was produced by wet diamond coring, the pullout design bond strength has to be reduced by 30%.

Reduction factor for splitting with large concrete cover: $\delta = 0,306$ (Hilti additional data)

Fire Resistance

according to MFPA Leipzig, report **GS 3.2/09-122**

a) fire situation “anchorage”

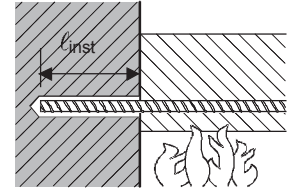

Maximum force in rebar in conjunction with HIT-RE 500 SD as a function of embedment depth for the fire resistance classes F30 to F240 (yield strength $f_{yk} = 500 \text{ N/mm}^2$) according EC2^{a)}.

| Bar \varnothing [mm] | Drill hole \varnothing [mm] | Max. $F_{s,T}$ [kN] | l_{inst} [mm] | Fire resistance of bar in [kN] | | | | | |
|---------------------------|-------------------------------------|------------------------|--------------------|--------------------------------|-------|-------|-------|-------|-------|
| | | | | R30 | R60 | R90 | R120 | R180 | R240 |
| 8 | 10 | 16,19 | 65 | 1,38 | 0,57 | 0,19 | 0,05 | 0 | 0 |
| | | | 80 | 2,35 | 1,02 | 0,47 | 0,26 | 0 | 0 |
| | | | 95 | 3,87 | 1,68 | 0,88 | 0,55 | 0,12 | 0 |
| | | | 115 | 7,30 | 3,07 | 1,71 | 1,14 | 0,44 | 0,18 |
| | | | 150 | 16,19 | 8,15 | 4,59 | 3,14 | 1,41 | 0,8 |
| | | | 180 | | 16,19 | 9,99 | 6,75 | 2,94 | 1,7 |
| | | | 205 | | | 16,19 | 12,38 | 5,08 | 2,86 |
| | | | 220 | | | | 16,19 | 6,95 | 3,82 |
| | | | 265 | | | | | 16,19 | 8,57 |
| | | | 305 | | | | | 16,19 | |
| 10 | 12 | 25,29 | 80 | 2,94 | 1,27 | 0,59 | 0,33 | 0 | 0 |
| | | | 100 | 5,68 | 2,45 | 1,31 | 0,85 | 0,24 | 0 |
| | | | 120 | 10,66 | 4,44 | 2,48 | 1,68 | 0,68 | 0,31 |
| | | | 140 | 17,57 | 7,76 | 4,38 | 2,99 | 1,33 | 0,73 |
| | | | 165 | 25,29 | 15,06 | 8,5 | 5,79 | 2,58 | 1,5 |
| | | | 195 | | 25,29 | 17,63 | 12,18 | 5,12 | 2,93 |
| | | | 220 | | | 25,29 | 20,66 | 8,69 | 4,78 |
| | | | 235 | | | | 25,29 | 11,8 | 6,30 |
| | | | 280 | | | | | 25,29 | 13,86 |
| | | | 320 | | | | 25,29 | | |
| 12 | 16 | 36,42 | 95 | 5,80 | 2,52 | 1,32 | 0,83 | 0,18 | 0 |
| | | | 120 | 12,79 | 5,33 | 2,97 | 2,01 | 0,82 | 0,37 |
| | | | 145 | 23,16 | 10,68 | 6,02 | 4,12 | 1,84 | 1,03 |
| | | | 180 | 36,42 | 24,29 | 14,99 | 10,12 | 4,41 | 2,55 |
| | | | 210 | | 36,42 | 27,38 | 20,65 | 8,47 | 4,74 |
| | | | 235 | | | 36,42 | 31,01 | 14,16 | 7,56 |
| | | | 250 | | | | 36,42 | 19,13 | 9,89 |
| | | | 295 | | | | | 36,42 | 21,43 |
| | | | | | | 335 | | | |
| 14 | 18 | 49,58 | 110 | 10,92 | 4,65 | 2,55 | 1,70 | 0,61 | 0,20 |
| | | | 140 | 24,60 | 10,87 | 6,13 | 4,19 | 1,86 | 1,03 |
| | | | 170 | 39,12 | 23,50 | 13,55 | 9,20 | 4,07 | 2,37 |
| | | | 195 | 49,58 | 35,6 | 24,69 | 17,05 | 7,17 | 4,10 |
| | | | 225 | | 49,58 | 39,20 | 31,34 | 13,48 | 7,34 |
| | | | 250 | | | 49,58 | 43,44 | 22,32 | 11,54 |
| | | | 265 | | | | 49,58 | 29,49 | 15,00 |
| | | | 310 | | | | | 49,58 | 31,98 |
| | | | | | | 350 | | | |

| Bar Ø | Drill hole Ø | Max. F _{s,T} | l _{inst} | Fire resistance of bar in [kN] | | | | | |
|-------|--------------|-----------------------|-------------------|--------------------------------|--------|--------|--------|--------|--------|
| [mm] | [mm] | [kN] | [mm] | R30 | R60 | R90 | R120 | R180 | R240 |
| 16 | 20 | 64,75 | 130 | 22,59 | 9,42 | 5,30 | 3,61 | 1,56 | 0,80 |
| | | | 160 | 39,17 | 21,33 | 11,95 | 8,15 | 3,65 | 2,11 |
| | | | 190 | 55,76 | 37,92 | 24,45 | 17,25 | 7,35 | 4,22 |
| | | | 210 | 64,75 | 48,98 | 36,51 | 27,53 | 11,29 | 6,32 |
| | | | 240 | | 64,75 | 53,10 | 44,12 | 20,88 | 11,04 |
| | | | 265 | | | 64,75 | 57,94 | 33,7 | 17,14 |
| | | | 280 | | | | 64,75 | 42,0 | 22,17 |
| | | | 325 | | | | | 64,75 | 44,84 |
| | | | 365 | | | | | | 64,75 |
| 20 | 25 | 101,18 | 160 | 48,97 | 26,67 | 14,93 | 10,18 | 4,56 | 2,64 |
| | | | 200 | 76,61 | 54,31 | 38,73 | 27,5 | 11,42 | 6,48 |
| | | | 240 | 101,18 | 81,96 | 66,37 | 55,15 | 26,10 | 13,8 |
| | | | 270 | | 101,18 | 87,11 | 75,88 | 45,58 | 23,36 |
| | | | 295 | | | 101,18 | 93,16 | 62,86 | 35,72 |
| | | | 310 | | | | 101,18 | 73,23 | 45,69 |
| | | | 355 | | | | | 101,18 | 76,79 |
| | | | 395 | | | | | | 101,18 |
| 25 | 30 | 158,09 | 200 | 95,77 | 67,89 | 48,41 | 34,37 | 14,27 | 8,10 |
| | | | 250 | 138,96 | 111,09 | 91,60 | 77,51 | 39,86 | 20,61 |
| | | | 275 | 158,09 | 132,69 | 113,2 | 99,17 | 61,30 | 31,81 |
| | | | 305 | | 158,09 | 139,12 | 125,09 | 87,22 | 52,79 |
| | | | 330 | | | 158,09 | 146,69 | 108,82 | 74,39 |
| | | | 345 | | | | 158,09 | 121,77 | 87,34 |
| | | | 390 | | | | | 158,09 | 126,22 |
| | | | 430 | | | | | | 158,09 |
| 32 | 40 | 259,02 | 255 | 183,40 | 147,72 | 122,78 | 104,82 | 56,35 | 28,80 |
| | | | 275 | 205,52 | 169,84 | 144,90 | 126,94 | 78,46 | 40,71 |
| | | | 325 | 259,02 | 225,13 | 200,19 | 182,23 | 133,75 | 89,68 |
| | | | 368 | | 259,02 | 238,89 | 220,93 | 172,46 | 128,39 |
| | | | 380 | | | 259,02 | 243,05 | 194,58 | 150,51 |
| | | | 395 | | | | 259,02 | 211,16 | 167,09 |
| | | | 440 | | | | | 259,02 | 216,86 |
| | | | 480 | | | | | | 259,02 |
| 36 | 42 - 46 | 327,82 | 290 | 249,87 | 209,73 | 181,67 | 161,46 | 106,93 | 59,10 |
| | | | 325 | 293,41 | 253,27 | 225,21 | 205,01 | 150,47 | 100,89 |
| | | | 355 | 327,82 | 290,59 | 262,54 | 242,33 | 187,80 | 138,22 |
| | | | 385 | | 327,82 | 299,86 | 279,65 | 225,12 | 175,54 |
| | | | 410 | | | 327,82 | 310,75 | 256,22 | 206,64 |
| | | | 425 | | | | 327,82 | 274,88 | 225,30 |
| | | | 470 | | | | | 327,82 | 281,28 |
| | | | 510 | | | | | | 327,82 |
| 40 | 47 | 404,71 | 320 | 319,10 | 274,50 | 243,33 | 220,87 | 160,28 | 105,19 |
| | | | 355 | 367,48 | 322,88 | 291,71 | 269,25 | 208,66 | 153,57 |
| | | | 385 | 404,71 | 364,35 | 333,18 | 310,72 | 250,13 | 195,04 |
| | | | 415 | | 404,71 | 374,64 | 352,19 | 291,60 | 236,51 |
| | | | 440 | | | 404,71 | 386,75 | 326,16 | 271,07 |
| | | | 455 | | | | 404,71 | 346,89 | 291,80 |
| | | | 500 | | | | | 404,71 | 354,01 |
| | | | 540 | | | | | | 404,71 |

b) bar connection parallel to slab or wall surface exposed to fire

Max. bond stress, τ_T , depending on actual clear concrete cover for classifying the fire resistance.

It must be verified that the actual force in the bar during a fire, $F_{s,T}$, can be taken up by the bar connection of the selected length, ℓ_{inst} . Note: Cold design for ULS is mandatory.

$$F_{s,T} \leq (\ell_{inst} - c_f) \cdot \phi \cdot \pi \cdot \tau_T \quad \text{where: } (\ell_{inst} - c_f) \geq \ell_s;$$

ℓ_s = lap length

ϕ = nominal diameter of bar

$\ell_{inst} - c_f$ = selected overlap joint length; this must be at least ℓ_s ,
but may not be assumed to be more than 80ϕ

τ_T = bond stress when exposed to fire

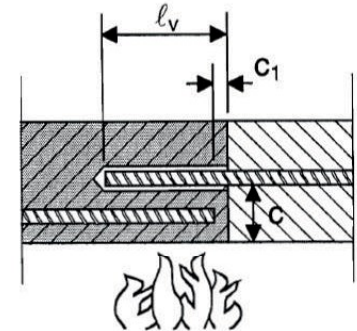

Critical temperature-dependent bond stress, τ_c , concerning “overlap joint” for Hilti HIT-RE 500-SD injection adhesive in relation to fire resistance class and required minimum concrete coverage c.

| Clear concrete cover c [mm] | Max. bond stress, τ_c [N/mm ²] | | | | | | | |
|--------------------------------|---|-------|-------|-------|-------|-------|------|------|
| | R30 | R60 | R90 | R120 | R180 | R240 | | |
| 10 | 0 | 0 | 0 | 0 | 0 | 0 | | |
| 20 | 0,49 | | | | | | | |
| 30 | 0,66 | | | | | | | |
| 40 | 0,89 | | | | | | | |
| 50 | 1,21 | | | | | | | |
| 60 | 1,63 | 0,80 | 0,51 | 0,49 | 0,45 | 0 | | |
| 70 | 2,19 | 1,04 | 0,65 | | | | | |
| 80 | 2,96 | 1,35 | 0,83 | | | | 0,61 | |
| 90 | 3,99 | 1,75 | 1,06 | | | | 0,77 | |
| 100 | 5,38 | 2,26 | 1,36 | | | | 0,97 | |
| 110 | 7,25 | 2,93 | 1,73 | 1,23 | 0,67 | 0,47 | | |
| 120 | 9,78 | 3,79 | 2,21 | 1,55 | 0,81 | 0,55 | | |
| 130 | 11,00 | 4,91 | 2,81 | 1,96 | 0,98 | 0,64 | | |
| 140 | | 6,35 | 3,59 | 2,47 | 1,18 | 0,76 | | |
| 150 | | 8,22 | 4,58 | 3,12 | 1,43 | 0,89 | | |
| 160 | | 10,65 | 5,84 | 3,94 | 1,73 | 1,04 | | |
| 170 | | 11,00 | 7,45 | 4,97 | 2,10 | 1,23 | 1,23 | |
| 180 | | | 9,51 | 6,27 | 2,54 | 1,44 | 1,44 | |
| 190 | | | 11,00 | 7,91 | 3,07 | 1,69 | 1,69 | 1,69 |
| 200 | | | | 9,99 | 3,71 | 1,99 | 1,99 | 1,99 |
| 210 | | | | 11,00 | 4,49 | 2,34 | 2,34 | 2,34 |
| 220 | | 5,44 | | | 2,75 | 2,75 | 2,75 | 2,75 |
| 230 | 6,58 | 3,22 | | | 3,22 | 3,22 | 3,22 | |
| 240 | 7,96 | 3,79 | 3,79 | | 3,79 | 3,79 | | |
| 250 | 9,64 | 4,45 | 4,45 | | 4,45 | 4,45 | | |
| 260 | 11,00 | 5,23 | 5,23 | 5,23 | 5,23 | 5,23 | | |
| 270 | | 6,14 | 6,14 | 6,14 | 6,14 | 6,14 | | |
| 280 | | 7,21 | 7,21 | 7,21 | 7,21 | 7,21 | | |
| 290 | | 8,47 | 8,47 | 8,47 | 8,47 | 8,47 | | |
| 300 | | 9,95 | 9,95 | 9,95 | 9,95 | 9,95 | | |
| 310 | 11,00 | 11,00 | 11,00 | 11,00 | 11,00 | 11,00 | | |

Basic design data for seismic rebar design

Bond strength $f_{bd,seism}$ in N/mm² according to DTA-3/10-649 for good bond conditions for hammer drilling, compressed air drilling, dry diamond core drilling

| Rebar (mm) | Concrete class | | | | | |
|------------|----------------|--------|--------|--------|--------|--------|
| | C20/25 | C25/30 | C30/37 | C35/45 | C40/50 | C45/55 |
| 8 | 2,3 | 2,7 | 3,0 | 3,4 | 3,7 | 4,0 |
| 10 | 2,3 | 2,7 | 3,0 | 3,4 | 3,7 | 4,0 |
| 12 | 2,3 | 2,7 | 3,0 | 3,4 | 3,7 | 3,7 |
| 14 | 2,3 | 2,7 | 3,0 | 3,4 | 3,7 | 3,7 |
| 16 | 2,3 | 2,7 | 3,0 | 3,4 | 3,7 | 3,7 |
| 18 | 2,3 | 2,7 | 3,0 | 3,4 | 3,7 | 3,7 |
| 20 | 2,3 | 2,7 | 3,0 | 3,4 | 3,7 | 3,7 |
| 22 | 2,3 | 2,7 | 3,0 | 3,0 | 3,4 | 3,4 |
| 24 | 2,3 | 2,7 | 3,0 | 3,0 | 3,4 | 3,4 |
| 25 | 2,3 | 2,7 | 3,0 | 3,0 | 3,4 | 3,4 |
| 26 | 2,3 | 2,7 | 3,0 | 3,0 | 3,0 | 3,0 |
| 28 | 2,3 | 2,7 | 3,0 | 3,0 | 3,0 | 3,0 |
| 30 | 2,3 | 2,7 | 3,0 | 3,0 | 3,0 | 3,0 |
| 32 | 2,3 | 2,7 | 3,0 | 3,0 | 3,0 | 3,0 |
| 34 | 2,3 | 2,6 | 2,9 | 2,7 | 2,7 | 2,7 |
| 36 | 2,2 | 2,6 | 2,9 | 2,7 | 2,7 | 2,7 |
| 40 | 2,1 | 2,5 | 2,7 | 2,7 | 2,7 | 2,7 |

Minimum anchorage length



The multiplication factor for minimum anchorage length shall be considered as 1,0 for all drilling methods.

Minimum anchorage and lap lengths for C20/25; maximum hole lengths (ETA 09/0295)

| Rebar | | Hammer drilling, Compressed air drilling, Dry diamond coring drilling | | Wet diamond coring drilling | | l_{max} [mm] |
|---------------------------|-----------------------------------|---|-----------------------|--------------------------------|-----------------------|-------------------|
| Diameter d_s [mm] | $f_{y,k}$ [N/mm ²] | $l_{b,min}^*$ [mm] | $l_{o,min}^*$ [mm] | $l_{b,min}^*$ [mm] | $l_{o,min}^*$ [mm] | |
| 8 | 500 | 113 | 200 | 170 | 300 | 1000 |
| 10 | 500 | 142 | 200 | 213 | 300 | 1000 |
| 12 | 500 | 170 | 200 | 255 | 300 | 1200 |
| 14 | 500 | 198 | 210 | 298 | 315 | 1400 |
| 16 | 500 | 227 | 240 | 340 | 360 | 1600 |
| 18 | 500 | 255 | 270 | 383 | 405 | 1800 |
| 20 | 500 | 284 | 300 | 425 | 450 | 2000 |
| 22 | 500 | 312 | 330 | 468 | 495 | 2200 |
| 24 | 500 | 340 | 360 | 510 | 540 | 2400 |
| 25 | 500 | 354 | 375 | 532 | 563 | 2500 |
| 26 | 500 | 369 | 390 | 553 | 585 | 2600 |
| 28 | 500 | 397 | 420 | 595 | 630 | 2800 |
| 30 | 500 | 425 | 450 | 638 | 675 | 3000 |
| 32 | 500 | 454 | 480 | 681 | 720 | 3200 |
| 34 | 500 | 492 | 510 | 738 | 765 | 3200 |
| 36 | 500 | 532 | 540 | 797 | 810 | 3200 |
| 40 | 500 | 616 | 621 | 925 | 932 | 3200 |

$l_{b,min}$ (8.6) and $l_{o,min}$ (8.11) are calculated for good bond conditions with maximum utilisation of rebar yield strength $f_{yk} = 500 \text{ N/mm}^2$ and $\alpha_6 = 1,0$

Hilti HIT-RE 500 mortar with rebar (as post-installed connection)

| Injection mortar system | Benefits |
|---|--|
|  <p>Hilti HIT-RE 500 330 ml foil pack (also available as 500 ml and 1400 ml foil pack)</p> | <ul style="list-style-type: none"> - SAFEset technology: drilling and borehole cleaning in one step with Hilti hollow drill bit - suitable for non-cracked concrete C 20/25 to C 50/60 - high loading capacity - suitable for dry and water saturated concrete - under water application - large diameter applications - high corrosion resistant - long working time at elevated temperatures - odourless epoxy |
|  <p>Static mixer</p> | |
|  <p>Rebar</p> | |

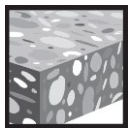

Concrete



Fire
resistance



Diamond
drilled
holes



European
Technical
Approval



DIBt approval



Drinking
water
approved



Corrosion
tested



PROFIS
Rebar design
software



Hilti **SAFEset**
technology with
hollow drill bit

Service temperature range

Temperature range: -40°C to +80°C (max. long term temperature +50°C, max. short term temperature +80°C).

Approvals / certificates

| Description | Authority / Laboratory | No. / date of issue |
|-----------------------------|------------------------|--------------------------|
| European technical approval | DIBt, Berlin | ETA-08/0105 / 2014-04-30 |
| European technical approval | DIBt, Berlin | ETA-04/0027 / 2013-06-26 |
| DIBt approval | DIBt, Berlin | Z-21.8-1790 / 2009-03-16 |
| Fire test report | IBMB Braunschweig | 3357/0550-5 / 2002-07-30 |
| Assessment report (fire) | Warringtonfire | WF 327804/B / 2013-07-10 |

a) All data given in this section according to the approvals mentioned above, ETA-08/0105 issue on 2014-04-30 and ETA-04/0027 issue on 2013-06-26.

Materials

Reinforcement bars according to EC2 Annex C Table C.1 and C.2N.

Properties of reinforcement

| Product form | | Bars and de-coiled rods | |
|---|--------------------------------|-------------------------|-----------------------|
| Class | | B | C |
| Characteristic yield strength f_{yk} or $f_{0,2k}$ (MPa) | | 400 to 600 | |
| Minimum value of $k = (f_t/f_y)_k$ | | $\geq 1,08$ | $\geq 1,15$ < 1,35 |
| Characteristic strain at maximum force, ϵ_{uk} (%) | | $\geq 5,0$ | $\geq 7,5$ |
| Bendability | | Bend / Rebend test | |
| Maximum deviation from nominal mass (individual bar) (%) | Nominal bar size (mm) ≤ 8 | $\pm 6,0$ | |
| | > 8 | $\pm 4,5$ | |
| Bond: Minimum relative rib area, $f_{R,min}$ | Nominal bar size (mm) 8 to 12 | 0,040 | |
| | > 12 | 0,056 | |

Setting details

For detailed information on installation see instruction for use given with the package of the product.

Curing time for general conditions



| Data according ETA-08/0105, issue 2014-04-30 | | | |
|--|--|------------------------------------|---|
| Temperature of the base material | Working time in which rebar can be inserted and adjusted t_{gel} | Initial curing time $t_{cure,ini}$ | Curing time before rebar can be fully loaded t_{cure} |
| $5\text{ °C} \leq T_{BM} < 10\text{ °C}$ | 2 h | 18 h | 72 h |
| $10\text{ °C} \leq T_{BM} < 15\text{ °C}$ | 90 min | 12 h | 48 h |
| $15\text{ °C} \leq T_{BM} < 20\text{ °C}$ | 30 min | 9 h | 24 h |
| $20\text{ °C} \leq T_{BM} < 25\text{ °C}$ | 20 min | 6 h | 12 h |
| $25\text{ °C} \leq T_{BM} < 30\text{ °C}$ | 20 min | 5 h | 12 h |
| $30\text{ °C} \leq T_{BM} < 40\text{ °C}$ | 12 min | 4 h | 8 h |
| $T_{BM} = 40\text{ °C}$ | 12 min | 4 h | 4 h |

For dry concrete curing times may be reduced according to the following table. For installation temperatures below +5 °C all load values have to be reduced according to the load reduction factors given below.

Curing time for dry concrete

| Additional Hilti technical data | | | | |
|----------------------------------|--|------------------------------------|---|-----------------------|
| Temperature of the base material | Working time in which rebar can be inserted and adjusted t_{gel} | Initial curing time $t_{cure,ini}$ | Reduced curing time before rebar can be fully loaded t_{cure} | Load reduction factor |
| $T_{BM} = -5\text{ °C}$ | 4 h | 36 h | 72 h | 0,6 |
| $T_{BM} = 0\text{ °C}$ | 3 h | 25 h | 50 h | 0,7 |
| $T_{BM} = 5\text{ °C}$ | 2 ½ h | 18 h | 36 h | 1 |
| $T_{BM} = 10\text{ °C}$ | 2 h | 12 h | 24 h | 1 |
| $T_{BM} = 15\text{ °C}$ | 1 ½ h | 9 h | 18 h | 1 |
| $T_{BM} = 20\text{ °C}$ | 30 min | 6 h | 12 h | 1 |
| $T_{BM} = 30\text{ °C}$ | 20 min | 4 h | 8 h | 1 |
| $T_{BM} = 40\text{ °C}$ | 12 min | 2 h | 4 h | 1 |

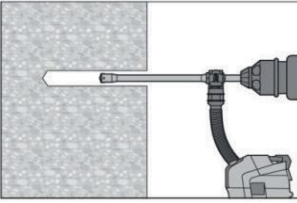
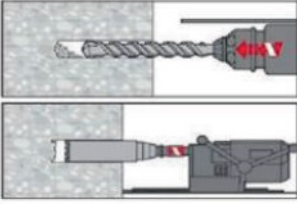
Setting instruction

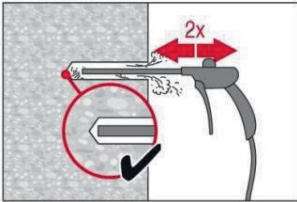
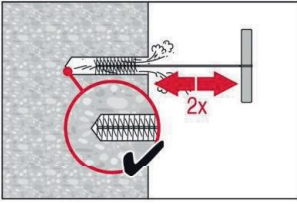
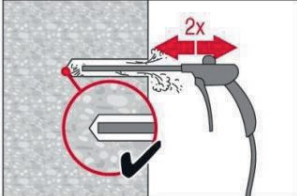
| | |
|---|---|
| <p>Safety Regulations:</p>  | <p>Review the Material Safety Data Sheet (MSDS) before use for proper and safe handling! Wear well-fitting protective goggles and protective gloves when working with Hilti HIT-RE 500. Important: Observe the installation instruction of the manufacturer provided with each foil pack.</p> |
| <p>1. Drill hole</p> | <p>Note: Before drilling, remove carbonized concrete; clean contact areas (see Annex B1) In case of aborted drill hole the drill hole shall be filled with mortar.</p> |
|  | <p>Drill hole to the required embedment depth with an appropriately sized Hilti TE-CD or TE-YD hollow drill bit with Hilti vacuum attachment. This drilling system removes the dust and cleans the bore hole during drilling when used in accordance with the user's manual. After drilling is complete, proceed to the "injection preparation" step in the instructions for use.</p> |
|  | <p>Drill the hole to the required embedment depth using a hammer-drill with carbid drill bit set in rotation hammer mode, a compressed air drill or a diamond core machine.</p> <p>Hammer drill (HD) Compressed air drill (CA) Diamond core wet (DD) and dry (PCC)</p>  |
| <p>4. Bore hole cleaning</p> | <p>(Not needed with Hilti TE-CD and Hilti TE-YD drill bit) The borehole must be free of dust, debris, water, ice, oil, grease and other contaminants prior to mortar injection. Just before setting an anchor, the bore hole must be free of dust and debris by one of two cleaning methods described below</p> |
| <p>Compressed air cleaning (CAC)</p> | |
|  | <p>Blowing 2 times from the back of the hole with oil-free compressed air (min. 6 bar at 100 litres per minute (LPM)) until return air stream is free of noticeable dust. Bore hole diameter ≥ 32 mm the compressor must supply a minimum air flow of 140 m³/hour. If required use additional accessories and extensions for air nozzle and brush to reach back of hole.</p> |
|  | <p>Brushing 2 times with the specified brush HIT-RB size (brush $\varnothing \geq$ borehole \varnothing) by inserting the round steel brush to the back of the hole in a twisting motion. The brush shall produce natural resistance as it enters the anchor hole. If this is not the case, please use a new brush or a brush with a larger diameter.</p> |
|  | <p>Blowing 2 times again with compressed air until return air stream is free of noticeable dust. If required use additional accessories and extensions for air nozzle and brush to reach back of hole.</p> |

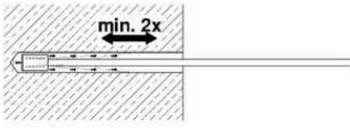

Deep boreholes – Blowing

For boreholes deeper than 250mm (for $\varnothing=8\text{mm} - 12\text{mm}$) or deeper than $20 \varnothing$ (for $\varnothing>12\text{mm}$) use the appropriate air nozzle Hilti HIT-DL

Safety tip: Do not inhale concrete dust.

The application of the dust collector Hilti HIT-DRS is recommended.

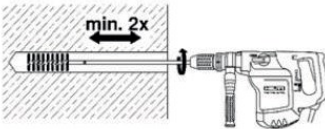

Deep boreholes – Brushing

For boreholes deeper than 250 mm (for $\varnothing=8\text{mm} - 12\text{mm}$) or deeper than $20 \varnothing$ (for $\varnothing>12\text{mm}$) use machine brushing and brush extensions HIT-RBS.

Screw the round steel brush HIT-RB in one end of the brush extension(s) HIT-RBS, so that the overall length of the brush is sufficient to reach the base of the borehole. Attach the other end of the extension to the TE-C/TE-Y chuck.

Safety tip:

- Start machine brushing operational slowly.
- Start brushing operation once brush is inserted in borehole.

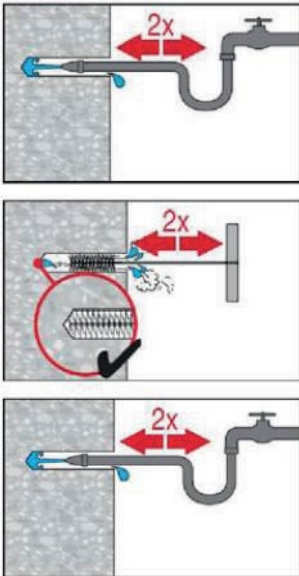

In addition for wet diamond coring (DD):

For wet diamond coring please observe the following steps in addition **prior to** compressed air cleaning:

Remove all core fragments from the anchor hole. Flush the anchor hole with clear running water until water runs clear. Brush the anchor hole again 2 times with the appropriate sized brush over the entire depth of the anchor hole. Repeat the flushing process until water runs out of the anchor hole.

Manual Cleaning (MC) Manual cleaning is permitted for hammer drilled boreholes up to hole diameters $d_0 \leq 20\text{mm}$ and depths l_v resp. $l_{e,ges.} \leq 160\text{mm}$.

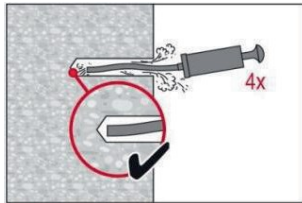

Blowing
4 strokes with Hilti blow-out pump from the back of the hole until return air stream is free of noticeable dust.

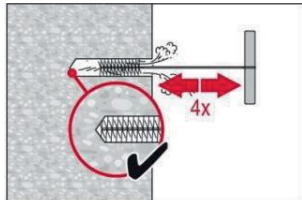

Brushing
4 times with the specified brush HIT_RB size (brush $\varnothing \geq$ borehole \varnothing) by inserting the round steel wire brush to the back of the hole with a twisting motion. The brush shall produce natural resistance as it enters the anchor hole. If this is not the case, please use a new brush or a brush with a larger diameter.

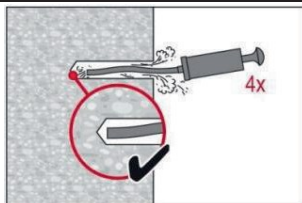

Blowing
4 strokes with Hilti blow-out pump from the back of the hole until return air stream is free of noticeable dust.



Manual Cleaning (MC)

Hilti hand pump recommended for blowing out bore hole with diameters $d < 20\text{mm}$ and bore hole depth $h_0 < 160\text{mm}$

3.Rebar preparation and foil pack preparation

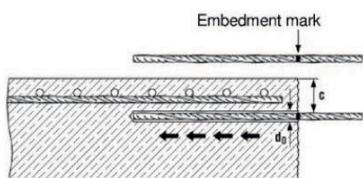

Before use, make sure the rebar is dry and free of oil or other residue.

Mark the embedment depth on the rebar. (e.g. with tape), l_v

Insert rebar in borehole, to verify hole and setting depth l_v resp. $l_{e,ges}$

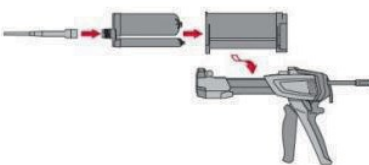

- Observe the Instruction for Use of the dispenser and the mortar.
- Tightly attach Hilti HIT-RE-M mixing nozzle to foil pack manifold.
- Insert foil pack into foil pack holder and swing holder into the dispenser.

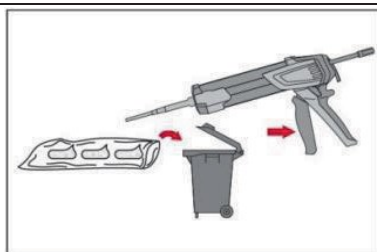

Discard initial mortar. The foil pack opens automatically as dispensing is initiated. Depending on the size of the foil pack an initial amount of adhesive has to be discarded. After changing a mixing nozzle, the first few trigger pulls must be discarded as described above. For each new foil pack a new mixing nozzle must be used.

Discard quantities are

- 3 strokes for 330 ml foil pack,
- 4 strokes for 500 ml foil pack,
- 65 ml for 1400 ml foil pack,

4.Inject mortar into borehole Forming air pockets be avoided

4.1 Injection method for borehole depth ≤ 250 mm

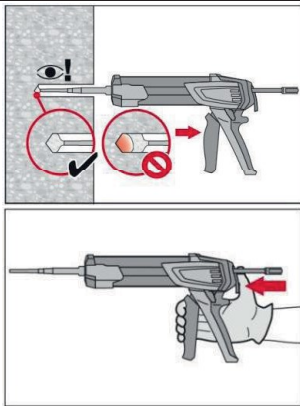

Inject the mortar from the back of the hole towards the front and slowly withdraw the mixing nozzle step by step after each trigger pull.
Fill holes approximately 2/3 full, or as required to ensure that the annular gap between the rebar and the concrete is completely filled with adhesive over the embedment length.
After injecting, depressurize the dispenser by pressing the release trigger. This will prevent further mortar discharge from the mixing nozzle.

4.2 Injection method for borehole depth > 250 mm or overhead application

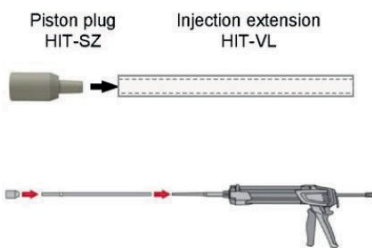

Assemble mixing nozzle HIT-RE-M, extension(s) and piston plug HIT-SZ.
For combinations of several injection extensions use coupler HIT-VL K. A substitution of the injection extension for a plastic hose or a combination of both is permitted.
The combination of HIT-SZ piston plug with HIT-VL 16 pipe and then HIT-VL 16 tube support proper injection.

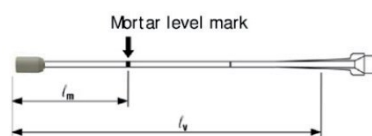

Mark the required mortar level l_m and embedment depth l_b resp. $l_{e,ges}$ with tape or marker on the injection extension.

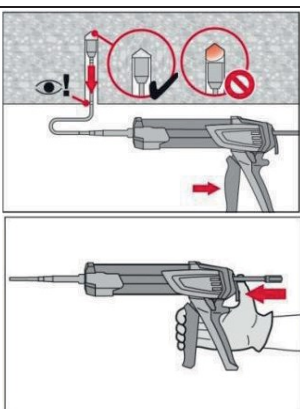

Insert piston plug to back of the hole. Begin injection allowing the pressure of the injected adhesive mortar to push the piston plug towards the front of the hole.
Fill holes approximately 2/3 full, or as required to ensure that the annular gap between the rebar and the concrete is completely filled with adhesive over the embedment length.
Injection until the mortar level mark l_m becomes visible.
After injecting, depressurize the dispenser by pressing the release trigger. This will prevent further mortar discharge from the mixing nozzle.

5. Insert rebar

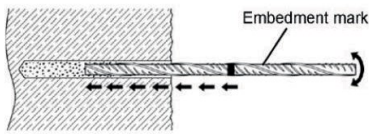

For easy installation insert the rebar slowly twisted into the borehole until the embedment mark is at the concrete surface level.

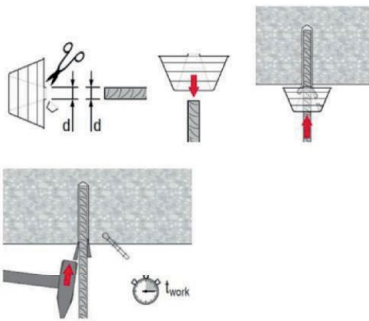

Overhead application:

During insertion of the rebar, mortar might flow out of the borehole. For collection of the flowing mortar, HIT-OHC may be used.

Support the rebar and secure it from falling till mortar started to harden, e.g. using wedges HIT-OHW.

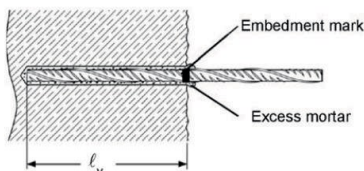

After installing the rebar the annular gap must be completely filled with mortar.

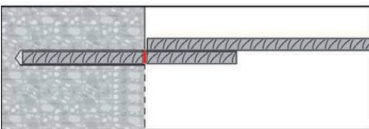

After installing the rebar the annular gap must be completely filled with mortar.

Proper installation can be verified when:

Desired anchoring embedment is reached l_v : embedment mark at concrete surface.

Excess mortar flows out of the borehole after the rebar has been fully inserted until the embedment mark.

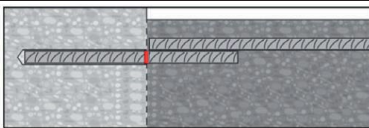

Full load may be applied only after the curing time " t_{cure} " has elapsed.

Fitness for use

Some creep tests have been conducted in accordance with ETAG guideline 001 part 5 and TR 023 in the following conditions : in dry environment at 50 °C during 90 days.

These tests show an excellent behaviour of the post-installed connection made with HIT-RE 500: low displacements with long term stability, failure load after exposure above reference load.

Resistance to chemical substances

| Categories | Chemical substances | resistant | Non resistant |
|------------------------|--|-----------|---------------|
| Alkaline products | Drilling dust slurry pH = 12,6 | + | |
| | Potassium hydroxide solution (10%) pH = 14 | + | |
| Acids | Acetic acid (10%) | | + |
| | Nitric acid (10%) | | + |
| | Hydrochloric acid (10%) | | + |
| | Sulfuric acid (10%) | | + |
| Solvents | Benzyl alcohol | | + |
| | Ethanol | | + |
| | Ethyl acetate | | + |
| | Methyl ethyl keton (MEK) | | + |
| | Trichlor ethylene | | + |
| | Xylol (mixture) | + | |
| Products from job site | Concrete plasticizer | + | |
| | Diesel | + | |
| | Engine oil | + | |
| | Petrol | + | |
| | Oil for form work | + | |
| Environnement | Sslt water | + | |
| | De-mineralised water | + | |
| | Sulphurous atmosphere (80 cycles) | + | |

Electrical Conductivity

HIT-RE 500 in the hardened state **does not conduct electrically**. Its electric resistivity is $66 \cdot 10^{12} \Omega \cdot m$ (DIN IEC 93 – 12.93). It is adapted well to realize electrically insulating anchorings (ex: railway applications, subway).

Drilling diameters

| Rebar (mm) | Drill bit diameters d_0 [mm] | | | |
|------------|---|------------------------------|------------------------|-----------|
| | Hammer drill (HD) Hollow Drill Bit (HDB) | Compressed air drill (CA) | Diamond coring | |
| | | | Wet (DD) | Dry (PCC) |
| 8 | 12 (10 ^{a)}) | - | 12 (10 ^{a)}) | - |
| 10 | 14 (12 ^{a)}) | - | 14 (12 ^{a)}) | - |
| 12 | 16 (14 ^{a)}) | 17 | 16 (14 ^{a)}) | - |
| 14 | 18 | 17 | 18 | - |
| 16 | 20 | 20 | 20 | - |
| 18 | 22 | 22 | 22 | - |
| 20 | 25 | 26 | 25 | - |
| 22 | 28 | 28 | 28 | - |
| 24 | 32 | 32 | 32 | 35 |
| 25 | 32 | 32 | 32 | 35 |
| 26 | 35 | 35 | 35 | 35 |
| 28 | 35 | 35 | 35 | 35 |
| 30 | 37 | 35 | 37 | 35 |
| 32 | 40 | 40 | 40 | 47 |
| 34 | 45 | 42 | 42 | 47 |
| 36 | 45 | 45 | 47 | 47 |
| 40 | 55 | 57 | 52 | 52 |

a) Max. installation length $l = 250$ mm.

Basic design data for rebar design according to rebar ETA

Bond strength in N/mm² according to ETA 08/0105 for good bond conditions for hammer drilling, compressed air drilling, dry diamond core drilling

| Rebar (mm) | Concrete class | | | | | | | | |
|------------|----------------|--------|--------|--------|--------|--------|--------|--------|--------|
| | C12/15 | C16/20 | C20/25 | C25/30 | C30/37 | C35/45 | C40/50 | C45/55 | C50/60 |
| 8 - 32 | 1,6 | 2,0 | 2,3 | 2,7 | 3,0 | 3,4 | 3,7 | 4,0 | 4,3 |
| 34 | 1,6 | 2,0 | 2,3 | 2,6 | 2,9 | 3,3 | 3,6 | 3,9 | 4,2 |
| 36 | 1,5 | 1,9 | 2,2 | 2,6 | 2,9 | 3,3 | 3,6 | 3,8 | 4,1 |
| 40 | 1,5 | 1,8 | 2,1 | 2,5 | 2,8 | 3,1 | 3,4 | 3,7 | 4,0 |

Bond strength in N/mm² according to ETA 08/0105 for good bond conditions for wet diamond core drilling

| Rebar (mm) | Concrete class | | | | | | | | |
|------------|----------------|--------|--------|--------|--------|--------|--------|--------|--------|
| | C12/15 | C16/20 | C20/25 | C25/30 | C30/37 | C35/45 | C40/50 | C45/55 | C50/60 |
| 8 - 25 | 1,6 | 2,0 | 2,3 | 2,7 | 3,0 | 3,4 | 3,7 | 4,0 | 4,3 |
| 26 - 32 | 1,6 | 2,0 | 2,3 | 2,7 | 2,7 | 2,7 | 2,7 | 2,7 | 2,7 |
| 34 | 1,6 | 2,0 | 2,3 | 2,6 | 2,6 | 2,6 | 2,6 | 2,6 | 2,6 |
| 36 | 1,5 | 1,9 | 2,2 | 2,6 | 2,6 | 2,6 | 2,6 | 2,6 | 2,6 |
| 40 | 1,5 | 1,8 | 2,1 | 2,5 | 2,5 | 2,5 | 2,5 | 2,5 | 2,5 |

Pullout design bond strength for Hit Rebar design

Design bond strength in N/mm² according to ETA 04/0027 (values in table are design values, $f_{bd,po} = \tau_{Rk}/\gamma_{Mp}$)

Hammer or compressed air drilling.
Water saturated, water filled or submerged hole.
Uncracked concrete C20/25.

| temperature range | Bar diameter | | | | | | | | | | | | | | | |
|-------------------|-------------------------------|----|-----|----|-----|-----|----|----|----|----|-----|----|----|-----|-----------------|-----|
| | Data according to ETA 04/0027 | | | | | | | | | | | | | | Hilti tech data | |
| | 8 | 10 | 12 | 14 | 16 | 20 | 22 | 24 | 25 | 26 | 28 | 30 | 32 | 36 | 40 | |
| I: 40°C/24°C | 7,1 | | 6,7 | | | 6,2 | | | | | | | | | 5,2 | 4,8 |
| II: 58°C/35°C | 5,7 | | | | 5,2 | | | | | | 4,8 | | | 4,3 | 3,8 | |
| III: 70°C/43°C | 3,3 | | | | | 3,1 | | | | | 2,9 | | | 2,4 | | |

Increasing factor in non-cracked concrete: $f_{B,p} = (f_{cck}/25)^{0,1}$ (f_{cck} : characteristic compressive strength on cube)

Additional Hilti Technical Data:

If the concrete is dry (not in contact with water before/during installation and curing), the pullout design bond strength may be increased by 20%.

If the hole was produced by wet diamond coring, the pullout design bond strength has to be reduced by 30%.

Reduction factor for splitting with large concrete cover: $\delta = 0,306$ (Hilti additional data)

Fire Resistance according to DIBt Z-21.8-1790

a) fire situation “anchorage”

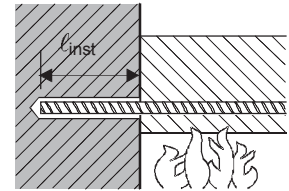

Maximum force in rebar in conjunction with HIT-RE 500 as a function of embedment depth for the fire resistance classes F30 to F180 (yield strength $f_{yk} = 500 \text{ N/mm}^2$) according EC2^{a)}.

| Bar \varnothing | Drill hole \varnothing | Max. $F_{s,T}$ | l_{inst} | Fire resistance of bar in [kN] | | | | |
|-------------------|--------------------------|----------------|------------|--------------------------------|------|------|------|------|
| | | | | R30 | R60 | R90 | R120 | R180 |
| [mm] | [mm] | [kN] | [mm] | | | | | |
| 8 | 10 | 16,19 | 80 | 2,4 | 1,0 | 0,5 | 0,3 | 0 |
| | | | 95 | 3,9 | 1,7 | 0,3 | 0,6 | 0,1 |
| | | | 115 | 7,3 | 3,1 | 1,7 | 1,1 | 0,4 |
| | | | 150 | 16,2 | 8,2 | 4,6 | 3,1 | 1,4 |
| | | | 180 | | 16,2 | 10,0 | 6,7 | 2,9 |
| | | | 205 | | | 16,2 | 12,4 | 5,1 |
| | | | 220 | | | | 16,2 | 7,0 |
| | | | 265 | | | | 16,2 | |
| 10 | 12 | 25,29 | 100 | 5,7 | 2,5 | 1,3 | 0,8 | 0,2 |
| | | | 120 | 10,7 | 4,4 | 2,5 | 1,7 | 0,7 |
| | | | 140 | 17,6 | 7,8 | 4,4 | 3,0 | 1,3 |
| | | | 165 | 25,3 | 15,1 | 8,5 | 5,8 | 2,6 |
| | | | 195 | | 25,3 | 17,6 | 12,2 | 5,1 |
| | | | 220 | | | 25,3 | 20,7 | 8,7 |
| | | | 235 | | | | 25,3 | 11,8 |
| | | | 280 | | | | 25,3 | |
| 12 | 16 | 36,42 | 120 | 12,8 | 5,3 | 3,0 | 2,0 | 0,8 |
| | | | 150 | 25,2 | 12,2 | 6,9 | 4,7 | 2,1 |
| | | | 180 | 36,4 | 24,3 | 15,0 | 10,1 | 4,4 |
| | | | 210 | | 36,2 | 27,4 | 20,6 | 8,5 |
| | | | 235 | | | 36,4 | 31,0 | 14,2 |
| | | | 250 | | | | 36,4 | 19,1 |
| | | | 295 | | | | 36,4 | |
| 14 | 18 | 49,58 | 140 | 24,6 | 10,9 | 6,1 | 4,2 | 1,9 |
| | | | 170 | 39,1 | 23,5 | 13,5 | 9,2 | 4,1 |
| | | | 195 | 49,6 | 35,6 | 24,7 | 17,1 | 7,2 |
| | | | 225 | | 49,6 | 39,2 | 31,3 | 13,5 |
| | | | 250 | | | 49,6 | 43,4 | 22,3 |
| | | | 265 | | | | 49,6 | 29,5 |
| | | | 310 | | | | 49,6 | |
| 16 | 20 | 64,75 | 160 | 39,2 | 21,3 | 11,9 | 8,1 | 3,6 |
| | | | 190 | 55,8 | 37,9 | 25,5 | 17,3 | 7,3 |
| | | | 210 | 64,8 | 49,0 | 36,5 | 27,5 | 11,3 |
| | | | 240 | | 64,8 | 53,1 | 44,1 | 20,9 |
| | | | 265 | | | 64,8 | 57,9 | 33,7 |
| | | | 280 | | | | 64,8 | 42,0 |
| | | | 325 | | | | 64,8 | |

| Bar Ø | Drill hole Ø | Max. F _{s,T} | ℓ _{inst} | | | | | |
|-------|--------------|-----------------------|-------------------|-------|-------|-------|-------|-------|
| | | | [mm] | R30 | R60 | R90 | R120 | R180 |
| 20 | 25 | 101,18 | 200 | 76,6 | 54,3 | 38,7 | 27,5 | 11,4 |
| | | | 240 | 101,2 | 82,0 | 66,4 | 55,1 | 26,1 |
| | | | 270 | | 101,2 | 87,1 | 75,9 | 45,6 |
| | | | 295 | | | 101,2 | 93,2 | 62,9 |
| | | | 310 | | | | 101,2 | 73,2 |
| | | | 355 | | | | | 101,2 |
| 25 | 30 | 158,09 | 250 | 139,0 | 111,1 | 91,6 | 77,6 | 39,9 |
| | | | 275 | 158,1 | 132,7 | 113,2 | 99,2 | 61,3 |
| | | | 305 | | 158,1 | 139,1 | 125,1 | 87,2 |
| | | | 330 | | | 158,1 | 146,7 | 108,8 |
| | | | 345 | | | | 158,1 | 121,8 |
| | | | 390 | | | | | 158,1 |
| 28 | 35 | 198,3 | 280 | 184,7 | 153,4 | 131,6 | 115,9 | 73,5 |
| | | | 295 | 198,3 | 168,0 | 146,1 | 130,4 | 88,0 |
| | | | 330 | | 198,3 | 180,0 | 164,3 | 121,9 |
| | | | 350 | | | 198,3 | 183,6 | 141,2 |
| | | | 370 | | | | 198,3 | 160,6 |
| | | | 410 | | | | | 198,3 |
| 32 | 40 | 259,02 | 320 | 255,3 | 219,6 | 194,7 | 176,7 | 128,2 |
| | | | 325 | 259,0 | 225,1 | 200,2 | 182,2 | 133,8 |
| | | | 360 | | 259,0 | 238,9 | 220,9 | 172,5 |
| | | | 380 | | | 259,0 | 243,1 | 194,6 |
| | | | 395 | | | | 259,0 | 211,2 |
| | | | 440 | | | | | 259,0 |
| 40 | 47 | 404,71 | 400 | 404,7 | 385,1 | 353,9 | 331,5 | 270,9 |
| | | | 415 | | 404,7 | 374,6 | 352,2 | 291,6 |
| | | | 440 | | | 404,7 | 386,8 | 326,2 |
| | | | 455 | | | | 404,7 | 346,9 |
| | | | 500 | | | | | 404,7 |

^{a)} For tables according the standards to DIN 1045-1988, NF-ENV 1991-2-2(EC2), Österreichische Norm B 4700-2000, British-, Singapore- and Australian Standards see Warringtonfire report WF 166402 or/and IBMB Braunschweig report No 3357/0550-5.

b) fire situation parallel

Max. bond stress, τ_T , depending on actual clear concrete cover for classifying the fire resistance.

It must be verified that the actual force in the bar during a fire, $F_{s,T}$, can be taken up by the bar connection of the selected length, ℓ_{inst} . Note: Cold design for ULS is mandatory.

$$F_{s,T} \leq (\ell_{inst} - c_f) \cdot \phi \cdot \pi \cdot \tau_T \quad \text{where: } (\ell_{inst} - c_f) \geq \ell_s;$$

ℓ_s = lap length

ϕ = nominal diameter of bar

$\ell_{inst} - c_f$ = selected overlap joint length; this must be at least ℓ_s ,
but may not be assumed to be more than 80ϕ

τ_T = bond stress when exposed to fire

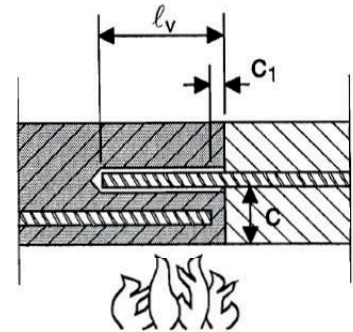

Critical temperature-dependent bond stress, τ_c , concerning “overlap joint” for Hilti HIT-RE 500 injection adhesive in relation to fire resistance class and required minimum concrete coverage c.

| Clear concrete cover c [mm] | Max. bond stress, τ_c [N/mm ²] | | | | | | | | |
|--------------------------------|---|-----|-----|------|------|-----|-----|-----|-----|
| | R30 | R60 | R90 | R120 | R180 | | | | |
| 30 | 0,7 | 0 | 0 | 0 | 0 | | | | |
| 35 | 0,8 | 0,4 | | | | | | | |
| 40 | 0,9 | 0,5 | | | | | | | |
| 45 | 1,0 | 0,5 | | | | | | | |
| 50 | 1,2 | 0,6 | | | | | | | |
| 55 | 1,4 | 0,7 | 0,5 | | | | | | |
| 60 | 1,6 | 0,8 | 0,5 | | | | | | |
| 65 | 1,9 | 0,9 | 0,6 | 0,4 | | | | | |
| 70 | 2,2 | 1,0 | 0,7 | 0,5 | | | | | |
| 75 | | 1,2 | 0,7 | 0,5 | | | | | |
| 80 | | 1,4 | 0,8 | 0,6 | | | | | |
| 85 | | 1,5 | 0,9 | 0,7 | | | | | |
| 90 | | 1,7 | 1,1 | 0,8 | 0,5 | | | | |
| 95 | | 2,0 | 1,2 | 0,9 | 0,5 | | | | |
| 100 | | 2,2 | 2,2 | 1,4 | 1,0 | 0,6 | | | |
| 105 | | | | 1,6 | 1,1 | 0,6 | | | |
| 110 | | | | 1,7 | 1,2 | 0,7 | | | |
| 115 | | | | 2,0 | 1,4 | 0,7 | | | |
| 120 | 2,2 | | | 2,2 | 2,2 | 1,6 | 0,8 | | |
| 125 | | | | | | 1,7 | 0,9 | | |
| 130 | | | | | | 2,0 | 1,0 | | |
| 135 | | | | | | 2,2 | 2,2 | 2,2 | 1,1 |
| 140 | | | | | | | | | 1,2 |
| 145 | | | | | | | | | 1,3 |
| 150 | | 1,4 | | | | | | | |
| 155 | | 1,6 | | | | | | | |
| 160 | | 1,7 | | | | | | | |
| 165 | | 1,9 | | | | | | | |
| 170 | 2,1 | | | | | | | | |
| 175 | 2,2 | | | | | | | | |

Minimum anchorage length





According to ETA-08/0105, issue 2014-04-30, the minimum anchorage length shall be increased by factor 1,5 for wet diamond core drilling. For all the other given drilling methods the factor is 1,0.

Minimum anchorage and lap lengths for C20/25; maximum hole lengths (ETA 08/0105)

| Rebar | | Hammer drilling, Compressed air drilling, Dry diamond coring drilling | | Wet diamond coring drilling | | |
|---------------------------|-----------------------------------|---|-----------------------|--------------------------------|-----------------------|-------------------|
| Diameter d_s [mm] | $f_{y,k}$ [N/mm ²] | $l_{b,min}^*$ [mm] | $l_{o,min}^*$ [mm] | $l_{b,min}^*$ [mm] | $l_{o,min}^*$ [mm] | l_{max} [mm] |
| 8 | 500 | 113 | 200 | 170 | 300 | 1000 |
| 10 | 500 | 142 | 200 | 213 | 300 | 1000 |
| 12 | 500 | 170 | 200 | 255 | 300 | 1200 |
| 14 | 500 | 198 | 210 | 298 | 315 | 1400 |
| 16 | 500 | 227 | 240 | 340 | 360 | 1600 |
| 18 | 500 | 255 | 270 | 383 | 405 | 1800 |
| 20 | 500 | 284 | 300 | 425 | 450 | 2000 |
| 22 | 500 | 312 | 330 | 468 | 495 | 2200 |
| 24 | 500 | 340 | 360 | 510 | 540 | 2400 |
| 25 | 500 | 354 | 375 | 532 | 563 | 2500 |
| 26 | 500 | 369 | 390 | 553 | 585 | 2600 |
| 28 | 500 | 397 | 420 | 595 | 630 | 2800 |
| 30 | 500 | 425 | 450 | 638 | 675 | 3000 |
| 32 | 500 | 454 | 480 | 681 | 720 | 3200 |
| 34 | 500 | 492 | 510 | 738 | 765 | 3200 |
| 36 | 500 | 532 | 540 | 797 | 810 | 3200 |
| 40 | 500 | 616 | 621 | 925 | 932 | 3200 |

* $l_{b,min}$ (8.6) and $l_{o,min}$ (8.11) are calculated for good bond conditions with maximum utilisation of rebar yield strength $f_{yk} = 500 \text{ N/mm}^2$ and $\alpha_6 = 1,0$

Hilti HIT-HY 200 mortar with rebar (as post-installed connection)

| Injection mortar system | Benefits |
|---|--|
|  <p>Hilti HIT-HY 200-R 330 ml foil pack (also available as 500 ml foil pack)</p>  <p>Hilti HIT-HY 200-A 330 ml foil pack (also available as 500 ml foil pack)</p>  <p>Static mixer</p>  <p>Rebar</p> | <ul style="list-style-type: none"> - SAFEset technology: drilling and borehole cleaning in one step with Hilti hollow drill bit - HY 200-R version is formulated for best handling and cure time specifically for rebar applications - Suitable for concrete C 12/15 to C 50/60 - Suitable for dry and water saturated concrete - For rebar diameters up to 32 mm - Non corrosive to rebar elements - Good load capacity at elevated temperatures - Suitable for embedment length up to 1000 mm - Suitable for applications down to -10 °C - Two mortar (A and R) versions available with different curing times and same performance |

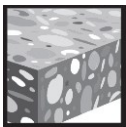

Concrete



Fire resistance



European Technical Approval



Corrosion tested



PROFIS Rebar design software



Hilti **SAFEset** technology with hollow drill bit

Service temperature range

Temperature range: -40°C to +80°C (max. long term temperature +50°C, max. short term temperature +80°C).

Approvals / certificates

| Description | Authority / Laboratory | No. / date of issue |
|---|------------------------|--|
| European technical approval ^{a)} | DIBt, Berlin | ETA-12/0083 / 2013-06-05 (HIT-HY 200-R) ETA-11/0492 / 2013-06-05 (HIT-HY 200-A) |
| Fire test report | CSTB, Paris | 26033756 |

a) All data given in this section according ETA-12/0083, issued 2013-06-05 and ETA-11/0492, issued 2013-06-05.

Materials

Reinforcement bars according to EC2 Annex C Table C.1 and C.2N.

Properties of reinforcement

| Product form | | Bars and de-coiled rods | |
|---|-----------------------|-------------------------|-----------------------|
| Class | | B | C |
| Characteristic yield strength f_{yk} or $f_{0,2k}$ (MPa) | | 400 to 600 | |
| Minimum value of $k = (f_t/f_y)_k$ | | $\geq 1,08$ | $\geq 1,15$ < 1,35 |
| Characteristic strain at maximum force, ϵ_{uk} (%) | | $\geq 5,0$ | $\geq 7,5$ |
| Bendability | | Bend / Rebend test | |
| Maximum deviation from nominal mass (individual bar) (%) | Nominal bar size (mm) | | |
| | ≤ 8 | $\pm 6,0$ | |
| | > 8 | $\pm 4,5$ | |
| Bond: Minimum relative rib area, $f_{R,min}$ | Nominal bar size (mm) | | |
| | 8 to 12 | 0,040 | |
| | > 12 | 0,056 | |

Setting details

For detailed information on installation see instruction for use given with the package of the product.

Working time, curing time^{a)}

| Temperature of the base material | HIT-HY 200-R | |
|----------------------------------|--|--|
| | Working time in which anchor can be inserted and adjusted t_{work} | Curing time before anchor can be fully loaded t_{cure} |
| -10 °C to -5 °C | 3 hour | 20 hour |
| -4 °C to 0 °C | 2 hour | 7 hour |
| 1 °C to 5 °C | 1 hour | 3 hour |
| 6 °C to 10 °C | 40 min | 2 hour |
| 11 °C to 20 °C | 15 min | 1 hour |
| 21 °C to 30 °C | 9 min | 1 hour |
| 31 °C to 40 °C | 6 min | 1 hour |

| Temperature of the base material | HIT-HY 200-A | |
|----------------------------------|--|--|
| | Working time in which anchor can be inserted and adjusted t_{work} | Curing time before anchor can be fully loaded t_{cure} |
| -10 °C to -5 °C | 1,5 hour | 7 hour |
| -4 °C to 0 °C | 50 min | 4 hour |
| 1 °C to 5 °C | 25 min | 2 hour |
| 6 °C to 10 °C | 15 min | 1 hour |
| 11 °C to 20 °C | 7 min | 30 min |
| 21 °C to 30 °C | 4 min | 30 min |
| 31 °C to 40 °C | 3 min | 30 min |

Setting instruction

a) Dry and water-saturated concrete, hammer drilling

Bore hole drilling

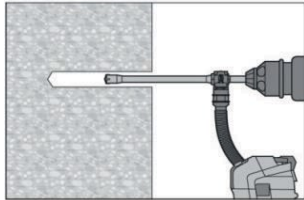

Drill hole to the required embedment depth with an appropriately sized Hilti TE-CD or TE-YD hollow drill bit with Hilti vacuum attachment. This drilling method properly cleans the borehole and removes dust while drilling. After drilling is complete, proceed to the "injection preparation" step in the instructions for use.

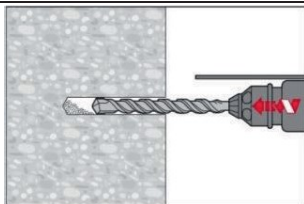

Drill hole to the required embedment depth using a hammer-drill with carbide drill bit set in rotation hammer mode, a Hilti hollow drill bit or a compressed air drill.

Bore hole cleaning Just before setting an anchor, the bore hole must be free of dust and debris by one of two cleaning methods described below

b) Compressed air cleaning (CAC)

For all bore hole diameters d_0 and all bore hole depth h_0

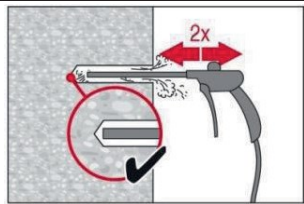

Blowing 2 times from the back of the hole with oil-free compressed air (min. 6 bar at 100 litres per minute (LPM)) until return air stream is free of noticeable dust. Bore hole diameter ≥ 32 mm the compressor must supply a minimum air flow of 140 m³/hour. If required use additional accessories and extensions for air nozzle and brush to reach back of hole.

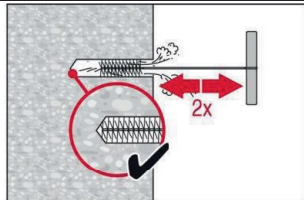

Brushing 2 times with the specified brush size (brush $\varnothing \geq$ borehole \varnothing) by inserting the round steel brush to the back of the hole in a twisting motion. The brush shall produce natural resistance as it enters the anchor hole. If this is not the case, please use a new brush or a brush with a larger diameter.

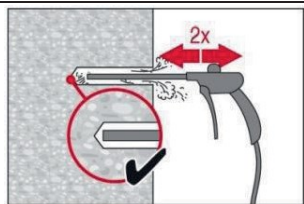

Blowing 2 times again with compressed air until return air stream is free of noticeable dust.

a) Manual Cleaning (MC)

As an alternative to compressed air cleaning, a manual cleaning is permitted for hammer drilled boreholes up to hole diameters $d_0 \leq 20\text{mm}$ and depths l_v resp. $l_{e,ges.} \leq 160\text{mm}$ or $10 * d$. The borehole must be free of dust, debris, water, ice, oil, grease and other contaminants prior to mortar injection.

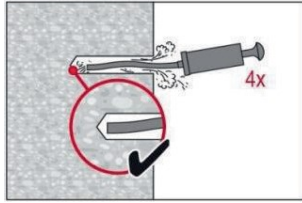

4 strokes with Hilti blow-out pump from the back of the hole until return air stream is free of noticeable dust.

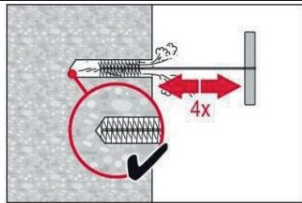

4 times with the specified brush size (brush $\varnothing \geq$ borehole \varnothing) by inserting the round steel wire brush to the back of the hole with a twisting motion

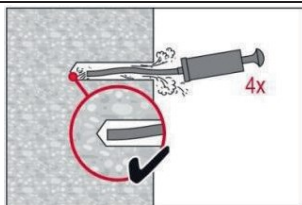

4 strokes with Hilti blow-out pump from the back of the hole until return air stream is free of noticeable dust.

Injection preparation

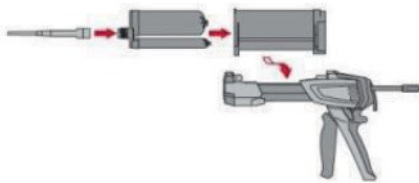

Observe the Instruction for Use of the dispenser.
Observe the Instruction for Use of the mortar.
Tightly attach Hilti HIT-RE-M mixing nozzle to foil pack manifold.
Insert foil pack into foil pack holder and swing holder into the dispenser.

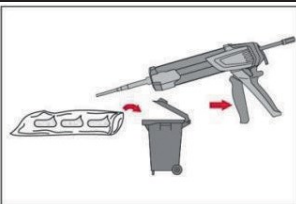

Discard initial adhesive. The foil pack opens automatically as dispensing is initiated. Depending on the size of the foil pack an initial amount of adhesive has to be discarded.

Discard quantities are

- 2 strokes for 330 ml foil pack,
- 3 strokes for 500 ml foil pack,
- 4 strokes for 500 ml foil pack $\leq 5^\circ\text{C}$.

Inject adhesive from the back of the borehole without forming air voids

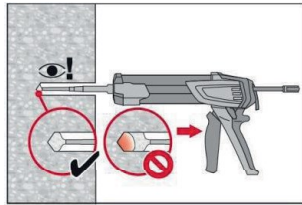

Injection method for borehole depth ≤ 250 mm:

Inject the mortar from the back of the hole towards the front and slowly withdraw the mixing nozzle step by step after each trigger pull. **Important! Use extensions for deep holes (> 250 mm).** Fill holes approximately 2/3 full, or as required to ensure that the annular gap between the rebar and the concrete is completely filled with adhesive over the embedment length.

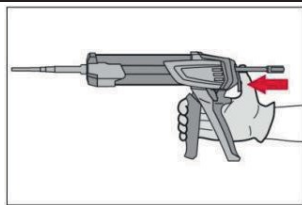

After injecting, depressurize the dispenser by pressing the release trigger (only for manual dispenser). This will prevent further mortar discharge from the mixing nozzle.

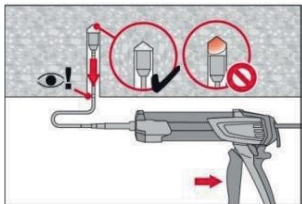

Piston plug injection for borehole depth > 250 mm or overhead applications:

Assemble mixing nozzle, extension(s) and appropriately sized piston plug. Insert piston plug to back of the hole. Begin injection allowing the pressure of the injected adhesive mortar to push the piston plug towards the front of the hole. After injecting, depressurize the dispenser by pressing the release trigger. This will prevent further mortar discharge from the mixing nozzle.

The proper injection of mortar using a piston plug HIT-SZ prevents the creation of air voids. The piston plug must be insertable to the back of the borehole without resistance. During injection the piston plug will be pressed towards the front of the borehole slowly by mortar pressure. Attention! Pulling the injection or when changing the foil pack, the piston plug is rendered inactive and air voids may occur.

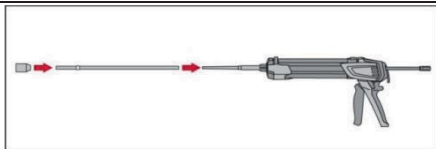

HDM 330 Manual dispenser (330 ml)
HDM 500 Manual dispenser (330 / 500 ml)
HDE 500-A22 Electric dispenser (330 / 500 ml)

Setting the element

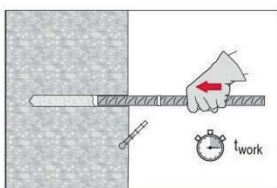

Before use, verify that the element is dry and free of oil and other contaminants.

Mark and set element to the required embedment depth until working time t_{work} has elapsed.

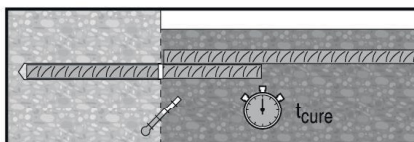

After installing the rebar the annular gap must be completely filled with mortar.

Proper installation can be verified when:

Desired anchoring embedment is reached ℓ_v :

Embedment mark at concrete surface.

Excess mortar flows out of the borehole after the rebar has been fully inserted until the embedment mark.

Overhead application: Support the rebar and secure it from falling till mortar started to harden.

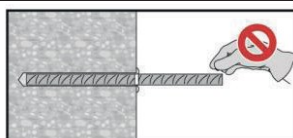

Observe the working time " t_{work} ", which varies according to temperature of base material. Minor adjustments to the rebar position may be performed during the working time. After t_{cure} preparation work may continue.

Resistance to chemical substances

| Chemical | Resistance | Chemical | Resistance |
|----------------------------------|------------|-----------------------------|------------|
| Air | + | Gasoline | + |
| Acetic acid 10% | + | Glycole | o |
| Acetone | o | Hydrogen peroxide 10% | o |
| Ammonia 5% | + | Lactic acid 10% | + |
| Benzyl alcohol | - | Machinery oil | + |
| Chloric acid 10% | o | Methylethylketon | o |
| Chlorinated lime 10% | + | Nitric acid 10% | o |
| Citric acid 10% | + | Phosphoric acid 10% | + |
| Concrete plasticizer | + | Potassium Hydroxide pH 13,2 | + |
| De-icing salt (Calcium chloride) | + | Sea water | + |
| Demineralized water | + | Sewage sludge | + |
| Diesel fuel | + | Sodium carbonate 10% | + |
| Drilling dust suspension pH 13,2 | + | Sodium hypochlorite 2% | + |
| Ethanol 96% | - | Sulfuric acid 10% | + |
| Ethylacetate | - | Sulfuric acid 30% | + |
| Formic acid 10% | + | Toluene | o |
| Formwork oil | + | Xylene | o |

- + resistant
- o resistant in short term (max. 48h) contact
- not resistant

Electrical Conductivity

HIT-HY 200 in the hardened state **is not conductive electrically**. Its electric resistivity is $15,5 \cdot 10^9 \Omega \cdot \text{cm}$ (DIN IEC 93 – 12.93). It is adapted well to realize electrically insulating anchorings (ex: railway applications, subway).

Drilling diameters

| Rebar (mm) | Drill bit diameters d_0 [mm] | |
|------------|--------------------------------|---------------------------|
| | Hammer drill (HD) | Compressed air drill (CA) |
| 8 | 12 (10 ^{a)}) | - |
| 10 | 14 (12 ^{a)}) | - |
| 12 | 16 (14 ^{a)}) | 17 |
| 14 | 18 | 17 |
| 16 | 20 | 20 |
| 18 | 22 | 22 |
| 20 | 25 | 26 |
| 22 | 28 | 28 |
| 24 | 32 | 32 |
| 25 | 32 | 32 |
| 26 | 35 | 35 |
| 28 | 35 | 35 |
| 30 | 37 | 35 |
| 32 | 40 | 40 |

a) Max. installation length $l = 250$ mm.

Basic design data for rebar design according to ETA

Bond strength

Bond strength in N/mm^2 according to ETA for good bond conditions

| Rebar (mm) | Concrete class | | | | | | | | |
|------------|----------------|--------|--------|--------|--------|--------|--------|--------|--------|
| | C12/15 | C16/20 | C20/25 | C25/30 | C30/37 | C35/45 | C40/50 | C45/55 | C50/60 |
| 8 - 32 | 1,6 | 2,0 | 2,3 | 2,7 | 3,0 | 3,4 | 3,7 | 4,0 | 4,3 |

Minimum anchorage length

Minimum and maximum embedment depths and lap lengths for C20/25 according to ETA

| Rebar | | $l_{b,min}^*$ [mm] | $l_{o,min}^*$ [mm] | Concrete temp. $\geq -10^\circ\text{C}$ | Concrete temp. $\geq 0^\circ\text{C}$ |
|------------------------|-----------------------------------|-----------------------|-----------------------|---|---------------------------------------|
| Diameter d_s [mm] | $f_{y,k}$ [N/mm ²] | | | l_{max} [mm] | l_{max} [mm] |
| 8 | 500 | 113 | 200 | 700 | 1000 |
| 10 | 500 | 142 | 200 | 700 | 1000 |
| 12 | 500 | 170 | 200 | 700 | 1000 |
| 14 | 500 | 198 | 210 | 700 | 1000 |
| 16 | 500 | 227 | 240 | 700 | 1000 |
| 18 | 500 | 255 | 270 | 700 | 1000 |
| 20 | 500 | 284 | 300 | 700 | 1000 |
| 22 | 500 | 312 | 330 | 700 | 1000 |
| 24 | 500 | 340 | 360 | 700 | 1000 |
| 25 | 500 | 354 | 375 | 700 | 1000 |
| 26 | 500 | 369 | 390 | 700 | 1000 |
| 28 | 500 | 397 | 420 | 700 | 1000 |
| 30 | 500 | 425 | 450 | 700 | 1000 |
| 32 | 500 | 454 | 480 | 700 | 1000 |

* $l_{b,min}$ (8.6) and $l_{o,min}$ (8.11) are calculated for good bond conditions with maximum utilisation of rebar yield strength $f_{yk} = 500 \text{ N/mm}^2$ and $\alpha_6 = 1,0$