

Szerelőrendszerek

Hilti. Tartósan teljesít.





Műszaki háttér

Műszaki tanácsadás, projekt támogatás, tervezői támogatás, szoftverek	536. oldal
MM sínrendszer – egyszerű, kényelmes, gyors	537. oldal



Csőbilincsek

Gumibetétes csőbilincsek	538. oldal
Gumibetét nélküli csőbilincsek	539. oldal
Hőszigetelt csőbilincsek	540. oldal
Rozsdamentes csőbilincsek	540. oldal
Tűzi horganyzott csőbilincsek	541. oldal



Speciális csőbilincsek

Speciális csőbilincsek	541. oldal
Sprinkler csőbilincsek	541. oldal



MQ sínrendszer horganyzott kivitelben

MQ sínrendszer, konzolok, csatlakozók, kiegészítők horganyzott kivitelben	542-543. oldal
Fixpont bilincsek	542. oldal
Csúszómegfogások	543. oldal



MM sínrendszer

MM sínrendszer, konzolok, csatlakozók, kiegészítők	544. oldal
--	------------



Légtechnikai rendszer

Légcsatorna bilincsek, függesztők, tartozékok	544. oldal
---	------------



MQ sínrendszer tűzi horganyzott és rozsdamentes kivitelben

MQ sínrendszer, konzolok, csatlakozók, kiegészítők tűzi horganyzott és rozsdamentes kivitelben	545. oldal
--	------------



Tartozékok

Rögzítőelemek és kiegészítők	546-547. oldal
------------------------------	----------------

Szerelő-
rendszerek

MÉRNÖKTANÁCSADÁS

Megoldást nyújtunk problémáira.

Műszaki tanácsadás

Mérnökeink készek tanácsot vagy komplett műszaki megoldást adni a tervezőirodáiban vagy akár az építkezés helyszínén is.

Szolgáltatásaink:

- Hilti szerelőrendszerek méretezése, a vonatkozó műszaki és teherbírási szabályoknak megfelelően
- Csőtartók helyszíni egyeztetése, műszaki dokumentációja AutoCAD, BIM, PDMS szoftverekkel
- Rögzítéstechnikai tanácsadás és méretezés
- Teherbírás igazolása próbahúzással, jegyzőkönyv készítésével
- Helyszíni tanácsadás fal- és födémáttörések tűzvédelmi lezárásáról a hatályban lévő szabályok és előírások szerint, a legoptimálisabb alkalmazás kiválasztásával.

Hilti szemináriumok és webináriumok

Lehetőséget biztosítunk, hogy bővítse tudását a következő területeken:

- Tűzgátlás
- Épületgépészeti szerelőrendszerek
- Rögzítéstechnika

Amennyiben érdeklődik szolgáltatásaink iránt, kérjük, keressen meg minket a Hilti Online-on vagy ügyfélszolgálatunkon keresztül.

Hilti szoftverek

Méretező programjaink ingyenesen elérhetők és letölthetők honlapunkról: www.hilti.hu

- Dűbelek és ragasztott betonacélok méretezése betonba és téglába a nemzetközi szabályozások szerint
 - PROFIS Anchor
 - PROFIS Rebar
- Fixpontok méretezése, a szükséges fixpont és csúszó megfogás kiválasztása
 - PROFIS Installation
- Csőtartók 2D/3D-s méretezése
 - PROFIS Installation
- Öszvérszerkezetű födémek és Hilti nyírócsapok méretezése az Eurocode alapján
- Mobilalkalmazások a Google Play-en és AppStore-on
 - Hilti Mobile App (Online Katalógus)
 - Dűbelválasztó program
 - Ragasztómennyiség-számítás
 - Hilti Fixpont Kiválasztó



MM rendszer

Egyszerű, kényelmes, gyors



Az MM szerelőrendszer közel 40 elemével lefedi a leggyakoribb kis- és közepes terhelésű gépészeti alkalmazásokat.



MM szerelőrendszer, ami forradalmian meggyorsítja a gépészeti szerelést. A széles sínprofil választék, az előszerelt csatlakozók, a sokféle tartozék radikálisan növeli a termelékenységet és biztosítja az egyszerű és kényelmes munkavégzést.

Könnyű szerelés a „Klik” mechanizmusnak köszönhetően. Nem is lehetne gyorsabb.





Bővebb információért, műszaki tartalmakért kérjük, keresse speciális **szerelőrendszer katalógusunkat**.

Hőszigetelt csőbilincsek



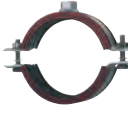

Hőszigetelő betéttel ellátott csőbilincsek

HILTI			MIP-H			MIP-M			MIP-T			Műszaki adatok acél csövekhez			
			Szigetelés vastagsága: 13 - 16 mm			Szigetelés vastagsága: 19 - 26 mm			Szigetelés vastagsága: 32 - 45 mm						
Cső külső (mm)	Méret col	Méret DN										Hőszigetelt vízzel teli cső súly (kg/m)	Alátámasztási távolság (m)	Egy függőleges pontra jutó max. teher (kg)	
10 - 13,5	1/4"		MIP-H/10-13	314126	MIP-M/10-14	314144									
15 - 18	3/8"	DN 10	MIP-H/15-18	314127	MIP-M/15-18	314145	MIP-T/15-18	314168	1,5	1,40	2,10				
21 - 25	1/2"	DN 15	MIP-H/21-25	314128	MIP-M/21-25	314146	MIP-T/21	314685	2,5	1,60	4,00				
24 - 26							MIP-T/25	314169							
27 - 30	3/4"	DN 20	MIP-H/27-30	314129	MIP-M/27-30	314147	MIP-T/27-30	314170	3,2	1,85	5,92				
34 - 38	1"	DN 25	MIP-H/34-38	314130	MIP-M/34-38	314148	MIP-T/34-35	314686	4,3	2,15	9,25				
42 - 45	1 1/4"	DN 32	MIP-H/42	314682	MIP-M/42-45	314149	MIP-T/42-45	314172	5,5	2,50	13,75				
44,5			MIP-H/45	314131											
48 - 51	1 1/2"	DN 40	MIP-H/48	314132	MIP-M/48	314150			6,0	2,60	15,60				
54 - 58			MIP-H/54-57	314133	MIP-M/54-57	314151	MIP-T/54	314687	7,6	2,80	21,28				
							MIP-T/57	314174							
60 - 64	2"	DN 50	MIP-H/60-64	314134	MIP-M/60-64	314152	MIP-T/60	314688	9,0	3,00	27,00				
63 - 65							MIP-T/64	314175	9,0						
74 - 80	2 1/2"	DN 65	MIP-H/76-80	314136	MIP-M/76-80	314154	MIP-T/76-80	314177	13,9	3,50	48,65				
87 - 93	3"	DN 80	MIP-H/89	314137	MIP-M/89	314155	MIP-T/89	314178	18,4	3,80	69,92				
99 - 104		DN 94	MIP-H/102	314138	MIP-M/102-108	314156	MIP-T/102-108	314179	24,8	4,00	99,20				
108 - 112		DN 100	MIP-H/108	314683					27,5	4,10	112,75				
113 - 117	4"		MIP-H/114	314139	MIP-M/114	314157	MIP-T/114	314180	28,8	4,20	120,95				
131 - 137		DN 125	MIP-H/133-140	314141	MIP-M/133	314684	MIP-T/133-140	314182	36,5	4,40	160,60				
137 - 142	5"				MIP-M/140	314159			38,2	4,50	171,90				
156 - 162		DN 150	MIP-H/159-160	314142	MIP-M/159-160	314160	MIP-T/159-160	314183	48,9	4,80	234,72				
165 - 168	6"		MIP-H/165-168	314143	MIP-M/165-168	314161	MIP-T/165-168	314184	50,6	4,90	247,94				
216 - 219		DN 200			MIP-M/216-219	314162	MIP-T/216-219	314185							
267 - 273		DN 250			MIP-M/267-273	314163			11,7	5,90	659,03				
321 - 328					MIP-M/324	314164									
352 - 358					*MIP-M/356	314165									
403 - 410					*MIP-M/406	314166									
454 - 451					*MIP-M/457	314167									



Rozsdamentes csőbilincsek

HILTI			Gumibetétes			Gumibetét nélküli			
			MP-SRNI	MP-MRI	MP-MRXI	MP-SRN	MP-MR		
Cső külső (mm)	Méret col	Méret DN							
			max. 130 kg-ig	max. 500 kg-ig	max. 1300 kg-ig	max. 250 kg-ig	max. 500 kg-ig		
15,5 - 18,5	3/8"	DN 10	MP-SRNI 17 M8	374186		MP-SRN 17 M8	254697		
19,5 - 22,5	1/2"	DN 15	MP-SRNI 21 M8	374187		MP-SRN 21 M8	254698		
25,5 - 28,5	3/4"	DN 20	MP-SRNI 27 M8	374188		MP-SRN 27 M8	254699		
33,0 - 37,0	1"	DN 25	MP-SRNI 34/36 M8	374189		MP-SRN 34 M8	254700		
34,5 - 37,5	36					MP-SRN 36 M10	254701		
36,5 - 39,5	38					MP-SRN 38 M10	254702		
38,0 - 44,0	1 1/4"	DN 32	MP-SRNI 38/42 M10	374192		MP-SRN 42 M10	254703		
48,0 - 52,0	1 1/2"	DN 40	MP-SRNI 48/50 M10	374193		MP-SRN 48/50 M10	254704		
54,0 - 58,0	57		MP-SRNI 57 M10	374194		MP-SRN 57 M10	254705		
58,5 - 61,5	2"	DN 50	MP-SRNI 60 M10	374195		MP-SRN 60 M10	254706		
61,5 - 64,5	63					MP-SRN 63 M10	254707		
68 - 72	68/72			MP-MRI 68/72 M10	372044			MP-MR 68/72 M10	374197
70 - 77	2 1/2"	DN 65		MP-MRI 2 1/2" M10	372045			MP-MR 2 1/2" M10	374198
78 - 84	78/84			MP-MRI 78/84 M10	372046				
82 - 90	3"	DN 80		MP-MRI 3" M10	372047			MP-MR 3" M10	374200
97 - 103	101,6			MP-MRI 101,6 M12	372048			MP-MR 101,6 M12	374201
108 - 114	4"	DN 100		MP-MRI 4" M12	372049			MP-MR 4" M12	374202
117 - 119	117			MP-MRI 117 M12	372050			MP-MR 117 M12	374203
122 - 127	125			MP-MRI 125 M12	372051			MP-MR 125 M12	374204
132 - 137	133			MP-MRI 133 M12	372052			MP-MR 133 M12	374205
137 - 142	5"	DN 125		MP-MRI 5" M16	372053			MP-MR 5" M16	374206
156 - 162	159			MP-MRI 159 M16	372054			MP-MR 159 M16	374207
162 - 168	6"	DN 150		MP-MRI 6" M16	372055			MP-MR 6" M16	374208
175 - 180	177,8			MP-MRI 177,8 M16	372056			MP-MR 177,8 M16	374209
190 - 200	193,7			MP-MRI 193,7 M16	372057			MP-MR 193,7 M16	374210
210 - 219	212			MP-MRI 212 M16	372058			MP-MR 212 M16	374211
217 - 224	219,1	DN 200		MP-MRI 219,1 M16	372059			MP-MR 219,1 M16	374212
244 - 253	244,5					MP-MRXI 244,5 M16	374213		
267 - 274	273	DN 250				MP-MRXI 273 M16	374214		
275 - 282	280					MP-MRXI 280 M16	374215		
314 - 324	324	DN 300				MP-MRXI 324 M16	374216		
324 - 330	326					MP-MRXI 326 M16	374217		
348 - 356	355					MP-MRXI 355 M16	374218		
400 - 409	406	DN 400				MP-MRXI 406 M16	374219		
454 - 462	457					MP-MRXI 457 M16	374220		
500 - 508	508	DN 500				MP-MRXI 508 M16	374221		



Tűzi horganyzott csőbilincsek

Tűzhorganyzott bilincsek										
HILTI			MP-MI-F		MP-M-F		MP-MXI-F		MP-MX-F	
Cső külső (mm)	Méret col	Méret DN		max. 300 kg-ig		max. 300 kg-ig		max. 300 kg-ig		max. 300 kg-ig
20 - 25	1/2"	DN 15	MP-MI-F 1/2" M10	304258	MP-M-F 1/2" M10	304269				
25 - 30	3/4"	DN 20	MP-MI-F 3/4" M10	304259	MP-M-F 3/4" M10	304270				
32 - 38	1"	DN 25	MP-MI-F 1" M10	304260	MP-M-F 1" M10	304271				
40 - 45	1 1/4"	DN 32	MP-MI-F 1 1/4" M10	304261	MP-M-F 1 1/4" M10	304272				
48 - 54	1 1/2"	DN 40	MP-MI-F 1 1/2" M10	304262	MP-M-F 1 1/2" M10	304273				
54 - 57	54/57		MP-MI-F 54/57 M10	304263	MP-M-F 54/57 M10	304274				
57 - 64	2"	DN 50	MP-MI-F 2" M10	304264	MP-M-F 2" M10	304275				
70 - 77	2 1/2"	DN 65	MP-MI-F 2 1/2" M10	304266	MP-M-F 2 1/2" M10	304277				
78 - 84	78/84		MP-MI-F 80/84	304267			60 - 65	MP-MXI-F 2" M10/M12	374897	MP-MX-F 2" M10/M12 374943
82 - 90	3"	DN 80	MP-MI-F 3"	304268	MP-M-F 3"	304278	73 - 78	MP-MXI-F 2 1/2" M10/M12	374898	MP-MX-F 2 1/2" M10/M12 374944
108 - 116	4"	DN 100					88 - 93	MP-MXI-F 3" M10/M12	374899	MP-MX-F 3" M10/M12 374945
122 - 126	125						108 - 116	MP-MXI-F 4" M16	374900	MP-MX-F 4" M16 374946
131 - 137	133						122 - 126	MP-MXI-F 125" M16	374901	MP-MX-F 125" M16 374947
139 - 144	5"	DN 125					131 - 137	MP-MXI-F 133 M16	374902	MP-MX-F 133 M16 374948
159 - 166	159						139 - 144	MP-MXI-F 5" M16	374903	MP-MX-F 5" M16 374949
163 - 170	6"	DN 150					159 - 166	MP-MXI-F 159 M16	374904	MP-MX-F 159 M16 374950
177 - 182	177,8						163 - 170	MP-MXI-F 6" M16	374905	MP-MX-F 6" M16 374951
192 - 200	193,7						177 - 182	MP-MXI-F 177,8 M16	374906	MP-MX-F 177,8 M16 374952
210 - 218	210						192 - 200	MP-MXI-F 193,7" M16	374907	MP-MX-F 193,7" M16 374953
219 - 228	219	DN 200					210 - 218	MP-MXI-F 210 M16	374908	MP-MX-F 210 M16 374954
244 - 253	244,5						219 - 228	MP-MXI-F 219 M16	374909	MP-MX-F 219 M16 374955
267 - 274	267/274	DN 250					244 - 253	MP-MXI-F 244,5 M16	374910	MP-MX-F 244,5 M16 374956
275 - 282	275						267 - 274	MP-MXI-F 267/274 M16	374911	MP-MX-F 267/274 M16 374957
315 - 324	324	DN 300					275 - 282	MP-MXI-F 275 M16	374912	MP-MX-F 275 M16 374958
325 - 330	326						315 - 324	MP-MXI-F 324 M16	374913	MP-MX-F 324 M16 374959
348 - 356	355						325 - 330	MP-MXI-F 326 M16	374914	MP-MX-F 326 M16 374960
364 - 372	368						348 - 356	MP-MXI-F 355 M16	374915	MP-MX-F 355 M16 374961
400 - 409	406	DN 400					364 - 372	MP-MXI-F 368 M16	374916	MP-MX-F 368 M16 374962
454 - 462	457						400 - 409	MP-MXI-F 406 M16	374917	MP-MX-F 406 M16 374963
500 - 508	508	DN 500					454 - 462	MP-MXI-F 457 M16	374918	MP-MX-F 457 M16 374964
							500 - 508	MP-MXI-F 508 M16	374919	MP-MX-F 508 M16 374965

Speciális csőbilincsek

Csúszó-szorító csőbilincsek műanyag vezetékhez	
MPN-GK	
	
	
MPN-GK 16 A	254905
MPN-GK 20 A	254907
MPN-GK 25 A	254909
MPN-GK 32 A	254911
MPN-GK 40 A	254913
MPN-GK 50 A	254915
MPN-G 56 F	254921
MPN-G 63 F	254923
MPN-G 75 F	254925
MPN-G 85 F	254927
MPN-G 90 F	254928
MPN-G 110 F	254931
MPN-G 120 F	254933
MPN-G 125 F	254935
MPN-G 135 F	254937
MPN-G 160 F	254939

Sprinkler csőbilincsek

MP-SP		MP-MS	
			
MP-SP 3/4" M8	216592	MP-MS 3/4" B	260520
MP-SP 1" M8	216593	MP-MS 1" B	260521
MP-SP 1 1/4" M8	216594	MP-MS 1 1/4" B	260522
MP-SP 1 1/2" M8	216595	MP-MS 1 1/2" B	260523
MP-SP 2" M8	216596	MP-MS 54/57 B*	260524
MP-SP 3/4" M10	229041	MP-MS 2" B	260525
MP-SP 1" M10	229042	MP-MS 68/72 H*	260526
MP-SP 1 1/4" M10	229043	MP-MS 2 1/2" H	260527
MP-SP 1 1/2" M10	229044	MP-MS 3" H	260529
MP-SP 2" M10	229045	MP-MS 101,6 H*	260530
MP-SP 2 1/2" M10	216597	MP-MS 4" H	260531
MP-SP 3" M10	216598	MP-MS 117 J*	260532
MP-SP 108* M10	216599	MP-MS 125 J*	260533
MP-SP 4" M10	216600	MP-MS 127 J*	260534
MP-SP 133* M12	216601	MP-MS 133 J*	260535
MP-SP 5" M12	216602	MP-MS 5" J	260536
MP-SP 159 M12	216603	MP-MS 152,4 J*	260537
MP-SP 6" M12	216604	MP-MS 159 J*	260538
MP-SP 219,1-M16	216605	MP-MS 6" J	260539

* Egyedi szállítási határidő

MQ szerelőrendszer - galvanikusan horganyzott

Sín					
MQ-21 2 m 304558	MQ-31 3 m 369589	MQ-41 2 m 304559	MQ-41 3 m 369591	MQ-52 3 m 373795	MQ-72 3 m 373797
MQ-21 3 m 369584	MQ-31 6 m 369590	MQ-41 3 m 369592	MQ-41/3 3 m 369596	MQ-52 6 m 369598	MQ-72 6 m 369599
MQ-21 6 m 369585			MQ-41/3 6 m 369597		
Dupla sín					
MQ-21 D 3 m 369601	MQ-41 D 3 m 369603	MQ-52-72 D 3 m 373799	MQ-124X D 6 m 369606	MQV-41 286101	MQW-P4 ① 369644
MQ-21 D 6 m 369602	MQ-41 D 6 m 369604	MQ-52-72 D 6 m 369605		MQV-72 286102	MQV-T ② 369645
				MQV-12 369643	
90 °-os sarokelemek					
MQW-Q2 369655	MQW-3 369656	MQW-4 369658	MQW-8/90° 369659	MQW-S/1 369664	MQW-S/2 369665
2D/3D kapcsolóelemek					
MQV-2/2 D 369638	MQV-2/2 D-14 369639	MQV-3/2 D 369640	MQV-3/3 D 369641	MQV-4/3 D 369642	MV-3/2D X 339590
Csatlakozóelemek betonhoz					
MQP-1/3 ① 369647	MQP-2/1 ① 377731	MQP-45° 369649	MQP-21-72 ① 369651	MQP-F6 ① 284240	
MQP-1/1 ② 369646	MQP-2/3 ② 369648		MQP-82 ② 369652	MQP-G ② 369654	
			MQP-124 ③ 369653		
MFP-L fixpont bilincs					
					M10, M12, M16
					MFP-L NW15 1/2" 310307
					MFP-L NW20 1/2" 310308
					MFP-L NW25 1/2" 310309
					MFP-L NW32 3/4" 310310
					MFP-L NW40 3/4" 310311
					MFP-L NW50 3/4" 310312
					MFP-L NW65 3/4" 310314
					MFP-L NW80 3/4" 310315
					MFP-L NW 4" 3/4" 310316
					MFP-L NW125 3/4" 310317
MFP-L fixpont csomag					
					MFP-LNW
					MFP-GP 1/2" 310 318
					MFP-GP 3/4" 310 319
					MFP-GP 1" 372 614
					Menetes cső
					GRST 1/2" 56 428
					GRST 3/4" 564 29
Fixpont bilincs					
MFP NW15 243521	MFP-NW Csőátmérő szerint	MFP-NW Csőátmérő szerint	MFP-NW Csőátmérő szerint	MFP-NW Csőátmérő szerint	
MFP NW20 243522					
MFP 28/30 243523	MFP-BP 20 247827	MFP-BP 20 247827	MFP-BP 20 247827	MFP-BP 16 247826	
MFP NW25 243524					
MFP NW32 243525	MFP-AP1 247829		MFP-AP2 247830	MFP-AP3 247831	
MFP NW40 243526	Menetes cső		Menetes cső	Menetes cső	
MFP NW54/56 243527	GR-G 1 1/4" 248532	GR-G 1 1/4" 248532	GR-G 1 1/4" 248532	GR-G 1 1/4" 248532	
MFP NW50 243528	Menetes rúd		Menetes rúd	Menetes rúd	
MFP 63/66 243529	AM 16*1000 4.8 216422		AM 16*1000 216422	AM 16*1000 216422	
MFP 68/72 243530	Dübel		Dübel	Dübel	
MFP NW65 243531	HST M 12/20 371587	Dübel	HST M 12/20 371587	HST M 12/20 371587	
MFP NW80 243532	HST M 16/25 371593	HST M 12/20 371587	HST M 16/25 371593	HST M 20/30 371598	
MFP NW100 243533					
MFP NW4" 243534					
MFP NW125/127 243535					
MFP NW125 243536					
MFP NW150 243537					
MFP NW6" 243538					
MFP 193/200 243539					
MFP NW200 243540					
MFP 244/250 243541					
MFP NW250 243542					

Bővebb információkért, műszaki tartalomért kérjük, keresse speciális szerelőrendszer katalógusunkat!

Konzolok		VdS		VdS		VdS	
	MQK-21/300 369607		MQK-41/300 369609		MQK-41/3/300 370595		MQK-72/450 369615
	MQK-21/450 369608		MQK-41/450 369610		MQK-41/3/450 370596		MQK-21 D/300 369617
			MQK-41/600 369611		MQK-41/3/600 370597		MQK-21 D/450 369618
			MQK-41/1000 369612				MQK-21 D/600 369619
							MQK41 D/1000 369620

Rögítőelemek		Rögítőgomb	
	MQK-H/300 HDG 2048096		MQN 369623
	MQK-H/600 HDG 2048097		
	MQK-H/750 HDG 2048098		
	MQK-H/900 HDG 2048099		
	MQK-SK 369622		
	MQK-SL 369621		
	MQZ-SV 369690		
	MQZ-SS 369691		

45 °-os sarokelemek		Szerelőbetét		Zárósapka	
	MQW-3/45° 369657		MQZ-U 369692		MQZ-E21 370598
	MQW-8/45° 369660				MQZ-E31 369686
	MQW-2/45° 369662				MQZ-E41 369685
	MQW-3/135° 369663				

Menetes csatlakozók és alátétlemezek		MQA-M6		MQA-M8		MQA-M10		MQA-M12		MQA-M16	
	MQA-Q8 369635		MQA-M6 369628		MQA-M8 369629		MQA-M10 369630		MQA-M12 369631		MQA-M16 369632
			MQA-M10-B 372471		MQG-2-M16 369682		MQM-M6 369624		MQZ-L9 369678		
			MQA-M12-B 369631		MQG-2-1/2" 369683		MQM-M8 369698		MQZ-L11 369679		
			MQA-M16-B 369632		MQG-2-3/4" 369684		MQM-M10 369626		MQZ-L13 369680		
							MQM-M12 369627		MQZ-L17 369681		

Tartókapocs		Csuklós tartókapcsok		3 D feszítőelemek		MQ3D-W45°		MQ3D-A	
	MQT 41 286107		MQT-G M8 284238		MQ3D-B 369694		MQ3D-W90° 369695		MQ3D-W45° 369696
			MQT-G M10 284239						MQ3D-A 369697







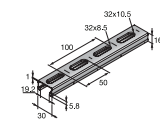
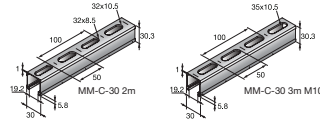
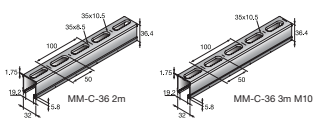
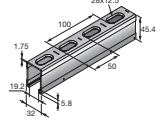
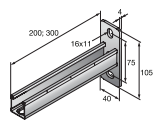
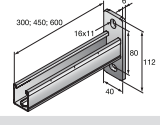
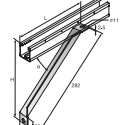
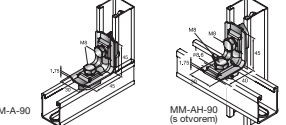
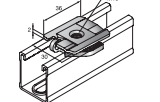
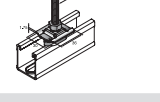
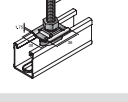
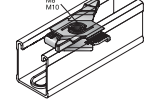
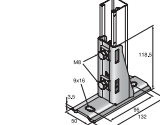
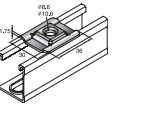
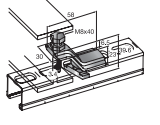
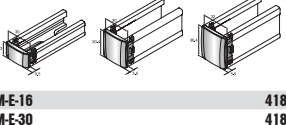



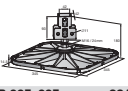







Tartókapocs		Hidak		MQB-52		MQB-82		MQB-G41		MQB-41x2	
	MQT-M10 284242		MQB-21 369666		MQB-52 369669		MQB-82 369671		MQB-G41 369674		MQB-41x2 369673
	MQT-M12 284243		MQB-31 369667		MQB-72 369670		MQB-124 369672				
	MQT-M16 284244		MQB-41 369668								

Tartókapocs		Csúszómegfogások		MSG 1,75 M UK		MSG 1,0 M8/10		MQP-UM12		MV-LDP	
	MAB-9 375956		SG 1,75 M8/M10 248209		MSG 1,75 M UK 337115		MPSG-M8 338994		MQP-UM12 284248		MV-LDP 335x335 2048106
	MAB-11 375957		MSG 1,75 M12/M16 248210		MRG 6,0 UK Keresztirányú csúszómegfogás		MPSG-M10 338995		MQP-UM16 284249		Izol. podl. MV-PSF 2050264
	MAB-13 375958				MRG 2,0 M10/M12 243550		MSG 1,0 M8/10 248 205				
	MAB-17 228155				MRG 4,0 M12/M16 243551		MSG 1,0 M12/16 248 206				
	MAB-S 11/13 374409		MRG-D6 334131				MSG 1,0 1/2" 248 207				
	MAB-S17 228156				MRG-D6, 0 UK 336755		MSG 1,0 3/4" 248 208				

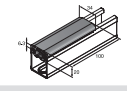
MM szerelőrendszer

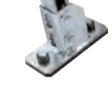
Sín	Sín	Sín	Sín
			
MM-C-16 2m 418748	MM-C-30 2m 418749 MM-C-30 3m M10 418776	MM-C-36 2m 418750 MM-C-36 3m M10 418751	MM-C-45 3m 2048104 MM-C-45 6m 2048105
Konzol	Konzol	Konzolátámasztó	Sarokelem
			
MM-B-30/200 418752 MM-B-30/300 418753	MM-B-36/300 418754 MM-B-36/450 418755 MM-B-36/600 418756	MM-AB 418772	MM-A-90 418757 MM-AH-90 418758
Bilincscsatlakozó	Gyorscsatlakozó	Gyorscsatlakozó	Szárnyas anya
			
MM-S M6 418759 MM-S M8 418760 MM-S M10 418761	MM-ST M8x40 418777 MM-ST M8x60 418778 MM-ST M8x80 418779 MM-ST M8x100 418780	MM-ST M10x40 418782 MM-ST M10x60 418791 MM-ST M10x80 418792 MM-ST M10x100 418793	MM-WN M6 418764 MM-WN M8 418765 MM-WN M10 418766
Talp	Alátétlemez	Tartókapocs	Zárósapka
			
MM-R-16-36 418762	MM-CW M8 418769 MM-CW M10 418770	MM-T-16-36 418763	MM-E-16 418773 MM-E-30 418774 MM-E-36 418775 MM-E-45 2048095

Légtechnikai rendszer

Teherelosztó lap	Klimakonzol szett	Lyuggatott szalagfüggesztő	Légszatórna-függesztő	Légszatórna-függesztő	Légszatórna bilincs
					
MV-LDP 335x335 2048106 Filc MV-PSF 2050264	MV-ACS 500 HDG 2048093 MV-ACS 780 HDG 2048093	MV-SI 386530	MVA-ZC 386531	MVA-Z 386532	MV-PI 80 M8 2047318 MV-PI 100 M8 2047319 MV-PI 125 M8 2048120 MV-PI 140 M8 2048121 MV-PI 150 M8 2048122 MV-PI 160 M8 2048123 MV-PI 180 M8 2048124 MV-PI 200 M8 2048125 MV-PI 224 M8/M10 386488 MV-PI 250 M8/M10 386489 MV-PI 280 M8/M10 386490 MV-PI 300 M8/M10 386491 MV-PI 315 M8/M10 386492 MV-PI 355 M8/M10 386493 MV-PI 400 M8/M10 386494 MV-PI 450 M8/M10 386495 MV-PI 500 M8/M10 386496 MV-PI 560 M8/M10 386497 MV-PI 600 M8/M10 386498 MV-PI 630 M8/M10 386499 MV-PI 710 386500 MV-PI 800 386501 MV-PI 900 386502 MV-PI 1000 386503 MV-PI 1120 386504 MV-PI 1250 386505
Légszatórna-függesztő	Légszatórna-függesztő	Légszatórna-függesztő	Légszatórna-függesztő trapézlemezhez	Légszatórna-függesztő trapézlemezhez	
					
MVA-LC 60 386533	MVA-LC 100 386534	MVA-L 60 386535	MVA-S 386544	MVA-MS 386545	
Szigetelő profilgumi	Szigetelő profilgumi	Rezgéscsillapító elem	Rezgéscsillapító elem	Rezgéscsillapító elem	
					
MQZ-RI 20 m 2047316 MQZ-RI 10 cm 2047317	MM-RI 20m 418767 MM-RI 10cm 418768	MVI-TB 386550	MVI-M8 T2 386551 MVI-M10 T2 386552	MVI-M8 T1 386553 MVI-M10 T1 386554	
Hangszigetelő lap	Rezgéscsillapító elem	Peremkapocs	Légszatórna-függesztő trapézlemezhez	Lyuggatott szalag	
					
MVI-P 386555	MVI-B 386556	MVZ-DC 2048088	MVA-MS M8 386558 MVA-MS M10 386559	LB 12 57711 LB 17 57712 LB 26 57713	

Trapézlemez lyukasztó



Trapézlemez lyukasztó TSH-Z 374004











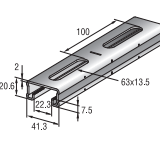
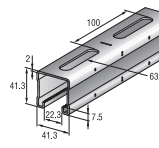
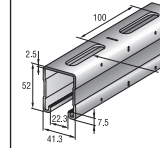
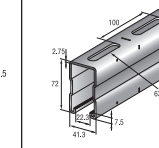
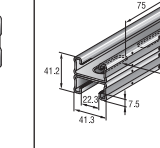
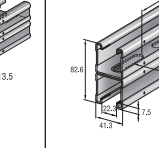
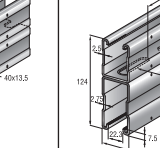
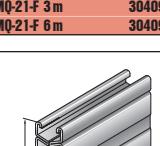

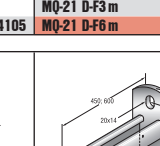
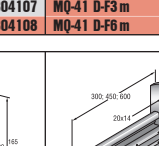
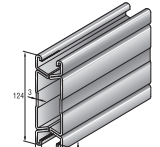
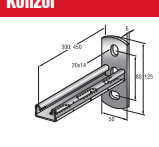
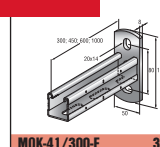
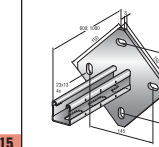
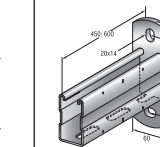
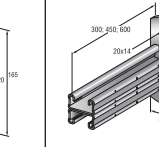
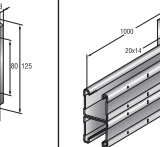
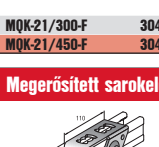
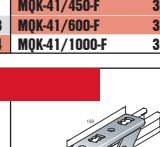

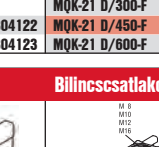
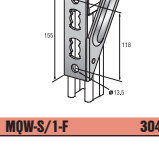
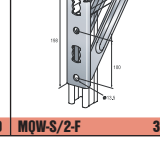
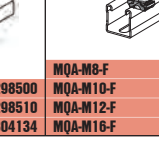
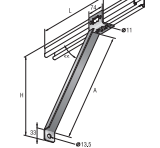
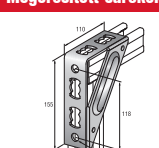
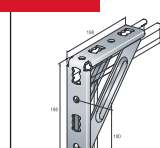
Légszatórna-függesztő trapézlemezhez

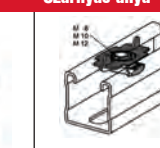
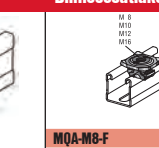
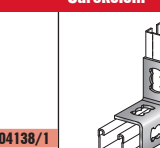
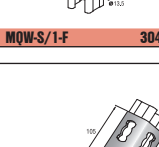
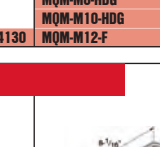

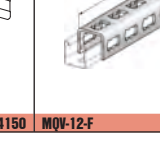
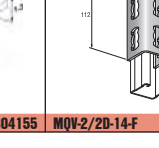
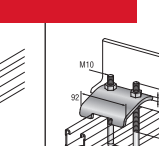
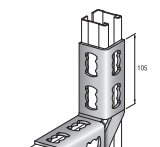
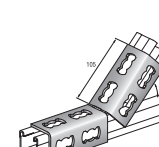
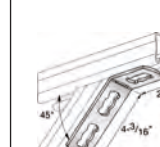
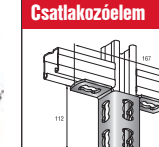
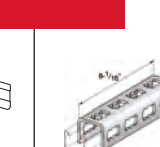
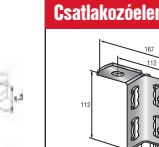
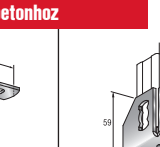
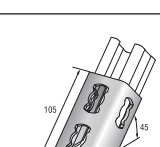
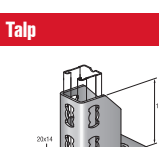
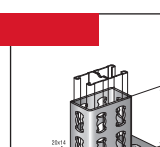
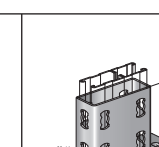
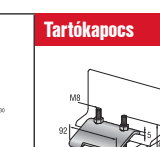
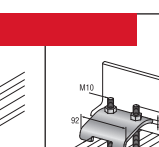
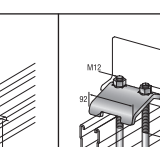
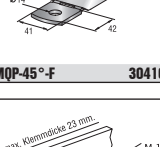
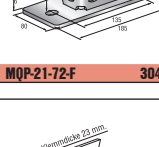
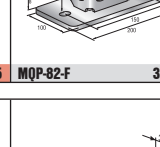
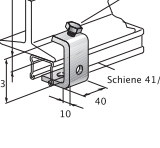
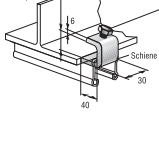
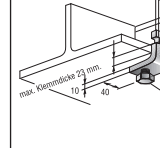
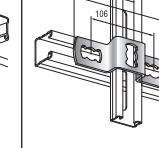
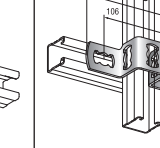
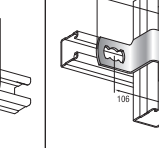
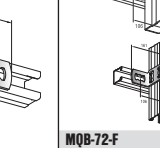
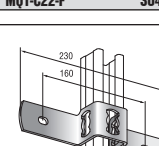
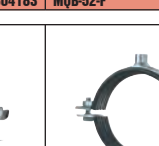
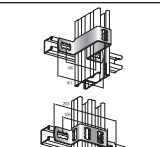
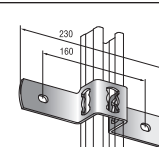
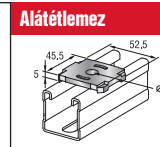
MF-TSH M8 229006
MF-TSH M8 229007

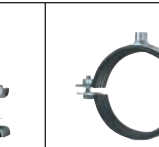
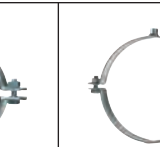
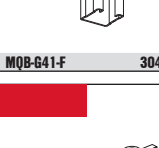
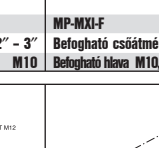
MQ szerelőrendszer - tűzi horganyzott és rozsdamentes

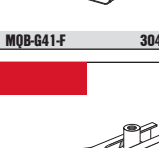
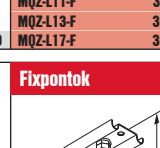
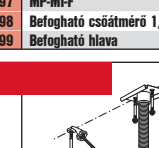
Rozsdamentes kivitelben is kapható.

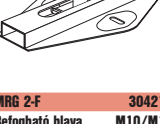
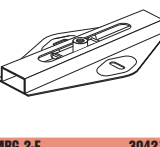
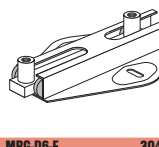
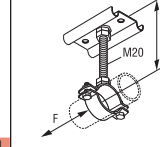
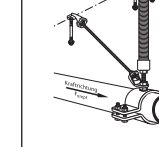
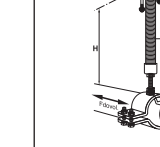
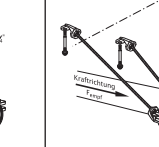
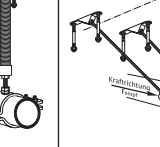
Sín						
 MQ-21-F 3m 304096	 MQ-41-F 3m 304099	 MQ-52-F 6m 304103	 MQ-72-F 6m 304105	 MQ-21 D-F3m 304107	 MQ-41 D-F3m 304109	 MQ-52-72 D-F6m 304112
 MQ-21-F 6m 304097	 MQ-41-F 6m 304100			 MQ-21 D-F6m 304108	 MQ-41 D-F6m 304110	
Konzol						
 MQ-124X D-F6m 370594	 MQK-21/300-F 304113	 MQK-41/300-F 304115	 MQK-41/600/4-F 304119	 MQK-72/450-F 304122	 MQK-21 D/300-F 304124	 MQK-41 D/1000-F 304127
	 MQK-21/450-F 304114	 MQK-41/450-F 304116	 MQK-41/1000/4-F 304120	 MQK-72/600-F 304123	 MQK-21 D/450-F 304125	
	 MQK-41/600-F 304117	 MQK-41/1000-F 304118			 MQK-21 D/600-F 304126	
Megerősített sarokelem		Csatlakozóelem		Szárnyas any	Bilincscsatlakozó	Sarokelem
 MQK-SK-F 304129	 MQK-SL-F 304128	 MQK-S/1-F 304180	 MQN-F 304130	 MQM-M8-HDG 298500	 MQA-M8-F 304138/1	 MQW-4-F 304174
	 MQW-S/2-F 304181			 MQM-M10-HDG 298510	 MQA-M10-F 304139/9	
				 MQM-M12-F 304134	 MQA-M12-F 304140/7	
					 MQA-M16-F 304141/5	
 MQW-8/90-F 304175	 MQW-8/45-F 304176	 MQW-3/45-F 304173	 MQV-2/20-F 304150	 MQV-12-F 304155	 MQV-2/20-14-F 304151	 MQP-2/3-F 304163
 MQP-45-F 304164	 MQP-21-72-F 304165	 MQP-82-F 304166	 MQP-124-F 304167	 MQT-21-41-F 304190	 MQT-41-82-F 304191	 MQT-82-124-F 304192
 MQT-21-41-F 304190	 MQT-41-82-F 304191	 MQT-82-124-F 304192				
 MQP-124-F 304187	 MQP-41x2-F 304188	 MQP-21-F 304182	 MQB-21-F 304182	 MQB-41-F 304183	 MQB-52-F 304184	 MQB-72-F 304185
	 MQP-82-F 304186					 MQB-82-F 304186
 MQZ-L9-F 304196	 MQZ-L11-F 304197	 MQZ-L13-F 304198	 MQZ-L17-F 304199	 MP-MI-F Befogható csőátmérő 1/2" - 3" Befogható hálva M10	 MP-M-F Befogható csőátmérő 1/2" - 3" Befogható hálva M10	 MP-MXI-F Befogható csőátmérő 2" - 508" Befogható hálva M10,12,16 ^{3/4} ,1
	 MQZ-L15-F 304199					 MP-MX-F Befogható csőátmérő 2" - 508" Befogható hálva M10,12,16 ^{3/4} ,1
 MQB-124-F 304187	 MQB-41x2-F 304188	 MQB-41-F 304183	 MQB-52-F 304184	 MQB-72-F 304185	 MQB-82-F 304186	
 MQB-82-F 304186						
Csúszómegfogások		Fixpontok				
 MRG-2-F Befogható hálva M10/M12 304213	 MRG-D6-F Befogható hálva M12/M16 304214	 MFP-L-F 1-2 kN	 MFP-1-F 3 kN	 MFP-1a-F max 3 kN	 MFP-2-F 10 kN	 MFP-3-F 20 kN

Megjegyzés: A teljes tűzhorganyzott portafóliónak csak egy részét tartalmazza a fenti lista. A teljes lista, bővebb információk és műszaki adatok megtalálhatók a Hilti speciális szerelőrendszer katalógusban. Kérjük, keresse mérnökeinket vagy szaktanácsadóinkat!

Szerelő-
rendszerek

Rögzítőelemek és kiegészítők

Ászokcsavarok

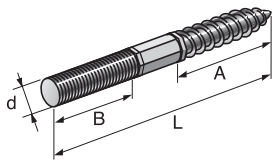

M 8/60	216361
M 8/80	216362
M 8/100	216363
M 8/130	216365
M 8/150	216366
M 10/80	216367
M 10/100	216368
M 10/150	216371
M 10/180	216372

Lyuggatott szalagok

Műanyag bevonattal



LKB 18 57724

Horganyzott



LB 12	57711
LB 17	57712
LB 26	57713

Laposfejű függesztőcsavarok



R6	58225
R8	58235
R10	58245

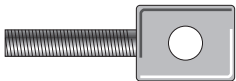

BS 6-20	58521
BS 6-40	58522
BS 8-20	58531
BS 8-40	58532
BS 10-20	58541
BS 10-40	58542

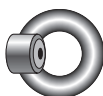

Ri M 8	365873
Ri M 10	365808
Ri M 12	365811
Ri M 16	365809
Ri M 20	365810
Ri M 24	365874

Toldókarmantyúk



Horganyzott	
M 6-30	216433
M 8-30	216435
M 12-40	216440
M 10-30	216437
M 10-40	216438
M 12-40	216440
M 16-60	216441

Tűzhorganyzott

M 8-25-F	304791
M 10-30-F	304792
M 12-40-F	304793
M 16-50-F	304794

Rozsdamentes

M 8-30 A4	266885
M 10-30 A4	266884
M 12-40 A4	266880
M 16-40 A4	266883

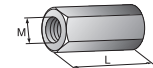

Hatlapú toldókarmantyú

M 8/25	216703
M 10/30	216704
M 12/40	216705
M 16/40	216706

Alaplemezek

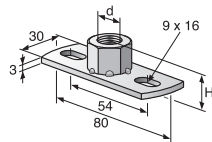

MGL2-M8	246908
MGL2-M 10	246909
MGL2-M 12	246910

Rozsdamentes

MGL2-R-M10	246928
MGL2-R-M16	246929

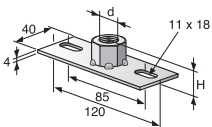

MGS2-M10	246913
MGS2-M12	246914
MGS2-M 16	246915

Rozsdamentes

MGS2-R-M10	246931
MGS2-R-M16	246932

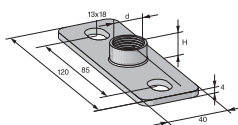

MGS2-1/2"	246916
MGS2-3/4"	246917

Rozsdamentes

MGS2-R-1/2"	246933
MGS2-R-3/4"	246934

Menetes rúdák

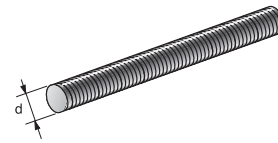

1m hossz	horganyzott	anyagminőség 4.8
AM 6-1000		339792
AM 8-1000		339793
AM 10-1000		339795
AM 12-1000		339797
AM 16-1000		216422
AM 20-1000		216425
AM 24-1000		216426

2m hossz	horganyzott	anyagminőség 4.8
AM 6-2000		216411
AM 8-2000		339794
AM 10-2000		339796
AM 12-2000		216420
AM 20-2000		212632

3m hossz	horganyzott	anyagminőség 4.8
AM 6-3000		216412
AM 8-3000		216415
AM 10-3000		216418
AM 12-3000		216421
AM 16-3000		216424

1m hossz	tűzhorganyzott	anyagminőség 4.6
AM 10-F 1 m		304773
AM 12-F 1 m		304774
AM 16-F 1 m		304776
AM 20-F 1 m		304778

2m hossz	tűzhorganyzott	anyagminőség 4.6
AM 12-F 2 m		304775
AM 16-F 2 m		304777
AM 20-F 2 m		304779

1m hossz	rozsdamentes	anyagminőség A4-70
AM 8-1000		58666
AM 10-1000		58670
AM 12-1000		58671
AM 16-1000		58683
AM 20-1000		58688
AM 24-1000		58689

A teljes portfólió elérhető: www.hilti.hu

Menetesszár-daraboló szerszámok

Leírás	db/cs.	Megnevezés	Cikkszám
Menetesszár-daraboló	1	MRC-M8/M10	295418
Vágóbetét	1	MRC-M6	295414
Vágóbetét	1	MRC-M8	295412
Vágóbetét	1	MRC-M10	295413

Menetes csövek



2m hossz	horganyzott	anyagminőség 4.6
GR-G 1/2"		56428
GR-G 3/4"		56429
GR-G 1"		56430
GR-G 1 1/4"		248532

1m hossz	tűzhorganyzott	anyagminőség 4.6
GR-G 1/2"		3047800
GR-G 3/4"		3047818
GR-G 1"		3047826
GR-G 1 1/4"		3047834

2m hossz	rozsdamentes	anyagminőség A4
GR-G 1/2" x 2 m		531111
GR-G 3/4" x 2 m		531129

Menetes adapterek

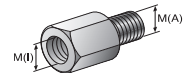

GA 8-10	47389
GA 8-12	47390
GA 10-12	47391
GA 10-1/2"	67584
GA 16-1/2"	67693
GA 16-3/4"	67728

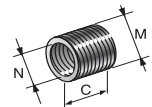

SR-RM 16-10	58146
SR-RM 3/4"-1/2"	230963
SR-RM 1/2"-M10	230964
SR-RM 1/2"-M16	230987
SR-RM 3/4"-M16	230988

Adapterek

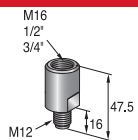

MQZ-A M16	369687
MQZ-A 1/2"	369688
MQZ-A 3/4"	369689



MRA-1/2"	338992
MRA-3/4"	338993
MRA-1"	372613

Bővebb információért, műszaki tartalomért kérjük, keresse speciális szerelőrendszer katalógusunkat!

Hatlapfejű csavarok

	M 10		Tűzhorganyzott	
	SSK M10-12	216 451	SSK-F M 8x25	304787
Horganyzott	SSK M10-16	216 452	SSK-F M10x25	304788
	SSK M10-20	216 453	SSK-F M12x25	304789
	SSK M10-25	216 454	SSK-F M16x30	304790
	SSK M10-35	216 455		
	SSK M10-55	216 456		
M 6	SSK M6-16	216 443	Rozsdamentes	
	SSK M6-25	216 444	SSK-R M 8x20	87 640
	SSK M6-40	216 445	SSK-R M10x20	26 839
M 8	SSK M8-16	216 446	SSK-R M10x25	87 632
	SSK M8-20	216 447	SSK-R M12x20	387 988
	SSK M8-25	216 448	SSK-R M12x25	87 634
	SSK M8-35	216 449		
	SSK M8-55	216 450		
M 12	SSK M12-20	216 457	A teljes portfólió elérhető: www.hilti.hu	
	SSK M12-25	216 458		
	SSK M12-35	216 459		
M 16	SSK M12-60	216 460		
	SSK M16-30	216 461		



Hatlapú anyák

	Horganyzott	
	SKM-M 4	216 463
Horganyzott	SKM-M 6	216 464
	SKM-M 8	216 465
	SKM-M 10	216 466
	SKM-M 12	216 467
	SKM-M 16	216 468
	SKM-M 20	216 469
	SKM-M 24	216 470
	Tűzhorganyzott	
	SKM-F M8	304764
	SKM-F M10	304765
SKM-F M12	304766	
SKM-F M16	304767	
SKM-F M20	304768	
Rozsdamentes		
SKM-A4-8	67 066	
SKM-A4-10	67 067	
SKM-A4-12	67 068	
SKM-A4-16	67 069	
SKM-A4-20	67 070	
SKM-A4-24	67 071	
A teljes portfólió elérhető: www.hilti.hu		

Alátétlemezek

Horganyzott	Tűzhorganyzott		
	A 6,4	282 849	A 8,4-F
A 8,4	282 850	A 10,5-F	304770
A 10,5	282 851	A 13-F	304771
A 13	282 852	A 17-F	304772
A 17	282 853		
A 21	282 854		
A 25	282 855	Rozsdamentes	
Fakötésű		A4-8,4	58622
A 8,4/28	282 861	A4-10,5	58042
A 8,4/40	282 856	A4-13	58041
A 10,5/28	282 862	A4-17	387989
A 10,5/40	282 857	A4-21	387990
A 13/40	282 858		
A teljes portfólió elérhető: www.hilti.hu			



Szárnycsavarok

	EFD-H M4	71 256
	EFD-H M6	308 890
	EFD-R M4	71 250
	EFD-R M6	308 889
	MF-SKD-M8/100	230 604
	MF-SKD-M8/200	230 605
MF-SKD-M8/300	230 606	
MF-SKD-M8/500	230 607	
MF-SKD-M10/100	230 608	
MF-SKD-M10/200	230 609	

Feszítőhüvelyek

	HKD-TE-CX Elhelyező szerszám	
	HKD-TE-CX M6 1/4"x25	414472
	HKD-TE-CX M8x25	414475
	HKD-TE-CX M10x25	414480
Normál készletelés		
HKD M 6x25	376 894	
HKD M 8x30	376 959	
HKD M 8x40	376 961	
HKD M 10x30	376 965	
HKD M 10x40	376 967	
HKD M 12x50	378 544	
HKD M 16x65	382 941	
HKD M 20x80	382 955	
Nagy készletelés		
HKD M 8x30	376 960	
HKD M 10x30	376 966	
HKD M 10x40	378 430	
HKD M 12x50	378 533	
Normál készletelés		
HKV 8x30	384 966	
HKV 10x30	384 968	
HKV 10x40	384 969	
HKV 12x50	384 971	
Nagy készletelés		
HKV 8x30	384 967	
HKV 10x40	384 970	
HKV 12x50	384 972	

Rögzítőelem

	HST	
	HST M 10/10	371 584
HST M 10/30	295 367	
HST M 10/50	371 586	
HST M 12/20	371 587	
HST M 12/50	371 588	
HST M 12/90	371 589	
HST M 12/120	371 590	
HST M 12/140	371 591	
HST M 12/160	371 592	
HST M 16/25	371 593	
HST M 16/50	371 594	
HST M 16/100	371 595	
HST M 16/140	371 596	
HST M 16/180	371 597	
HST M 20/30	371 598	
HST M 20/60	371 599	
HST M 24/30	371 601	
HST M 24/60	371 602	
Műanyag ék		
	HUD-1 10x50	331 618
	HUD-1 12x60	331 619
	HUD-1 14x70	331 620

	HSA	
	HSA M8x55 5/-/-	2004 122
HSA M8x70 20/10/-	2004 123	
HSA M8x85 35/25/-	2004 124	
HSA M8x105 55/45/15	2004 125	
HSA M8x130 80/70/40	2004 126	
HSA M10x68 5/-/-	2004 127	
HSA M10x83 20/10/-	2004 128	
HSA M10x98 35/25/-	2004 129	
HSA M10x113 50/40/10	2004 150	
HSA M10x133 70/60/30	2004 151	
HSA M10x153 90/80/50	2004 152	
HSA M10x168 105/95/65	2004 153	
HSA M12x85 5/-/-	2004 154	
HSA M12x100 20/5/-	2004 155	
HSA M12x115 35/20/-	2004 156	
HSA M12x145 65/50/15	2004 157	
HSA M12x175 95/80/45	2004 158	
HSA M12x205 125/110/75	2004 159	
HSA M12x225 145/130/95	2004 160	
HSA M16x102 5/-/-	2004 161	
HSA M16x117 20/5/-	2004 162	
HSA M16x137 40/25/-	2004 163	
HSA M16x182 85/70/30	2004 164	
HSA M16x232 135/120/80	2004 165	
A teljes portfólió elérhető: www.hilti.hu		